

SPRAY DRYER ADL311 / ADL311S

- Version 2 -

- Thank you for purchasing " Spray Dryer, ADL311(S)" of Yamato Scientific Co., Ltd.
- To use this unit properly, read this "Instruction Manual" thoroughly before using this unit. Keep this instruction manual around this unit for referring at anytime.

 **WARNING!:**

Carefully read and thoroughly understand the important warning items described in this manual before using this unit.

| | |
|---|----|
| 1. Safety precautions | 1 |
| Explanation of pictograms | 1 |
| List of symbols | 2 |
| Warning • Cautions | 3 |
| 2. Before using this unit. | 5 |
| Precautions when installing the unit | 5 |
| Service receptacle capacity | 8 |
| Temperature output terminal. | 8 |
| 3. Names of parts and their function. | 9 |
| Main unit + GF300 set. | 9 |
| Operation panel | 10 |
| 4. Operating procedures | 11 |
| Preparations | 11 |
| Operating method | 15 |
| Related Figure between Blower and Temperature/Drying Air Quantity (Reference) | 20 |
| 5. Handling Precautions | 21 |
| Drying Method under Appropriate Condition | 23 |
| Caution during operation. | 24 |
| 6. Maintenance Method. | 25 |
| Daily Inspection and Maintenance. | 25 |
| 7. Long storage and disposal | 27 |
| When not using this unit for long term / When disposing | 27 |
| Matters to consider when disposing of the unit | 27 |
| 8. When a trouble occurs | 28 |
| Safety unit and error indications | 28 |
| Confirmation and language select for the manual. | 29 |
| Trouble Shooting | 30 |
| 9. After Service and Warranty. | 32 |
| When requesting a repair | 32 |
| 10. Specification | 33 |
| 11. Wiring Diagram | 35 |
| ADL311 Wiring Diagram | 35 |
| ADL311 SWiring Diagram. | 37 |
| 12. System Chart | 39 |
| System Chart | 39 |
| 13. Principle of Operation | 40 |
| 14. Replacement parts table. | 41 |
| 15. List of Dangerous Substances. | 44 |
| 16. Standard installation manual | 45 |

1. Safety precautions

Explanation of pictograms

About pictograms

A variety of pictograms are indicated in this operating instruction and on products for safe operation. Possible results from improper operation ignoring them are as follows.

Be sure to fully understand the descriptions below before proceeding to the text.

 **Warning** Indicates a situation which may result in death or serious injury (Note 1.)

 **Caution** Indicates a situation which may result in minor injury (Note 2) and property damages (Note 3.)

(Note 1) Serious injury means a wound, an electrical shock, a bone fracture or intoxication that may leave after effects or require hospitalization or outpatient visits for a long time.

(Note 2) Minor injury means a wound or an electrical shock that does not require hospitalization or outpatient visits for a long time.

(Note 3) Property damage means damage to facilities, devices and buildings or other properties.

Meanings of pictograms



This pictogram indicates a matter that encourages the user to adhere to warning ("caution" included).
Specific description of warning is indicated near this pictogram.



This pictogram indicates prohibitions
Specific prohibition is indicated near this pictogram.



This pictogram indicates matters that the user must perform
Specific instruction is indicated near this pictogram.

1. Safety precautions

List of symbols

Warning



General warnings



Danger!: High voltage



Danger!: High temperature



Danger!: Moving part



Danger!: Hazard of explosion

Caution



General cautions



Electrical shock!



Burning!



Caution for no liquid heating!



Caution for water leak!



For water only



Poisonous material

Prohibitions



General bans



Fire ban



Do not disassemble



Do not touch

Compulsions



General compulsions



Connect ground wire



Install levelly



Pull out the power plug



Regular inspection

1. Safety precautions

Warning · Cautions

Warning



Do not use this unit in an area where there is flammable or explosive gas

Never use this unit in an area where there is flammable or explosive gas. This unit is not explosion-proof. An arc may be generated when the power switch is turned on or off, and fire/explosion may result. (Refer to page 44 “15. List of Dangerous Substances”.)



Always ground this unit

Always ground this unit on the power equipment side in order to avoid electrical shock due to a power surge.



Apply the source of rated power or more

Be sure to apply the source of rated power or more. Applying non-rated voltage or non-rated power supply may cause the fire or electric shock.



Prohibition of use for error

If a smoke or abnormal smell may be occurred, turn off the power switch of the main unit immediately, and turn off the original power source, and finally contact to either the dealer you purchased this unit or our sales office. Leaving the failure may cause the fire or electric shock. Since the repairing of this unit is dangerous for non-specified service person, never repair the unit by the customer himself.



Do not use the power cord if it is bundled or tangled

Do not use the power cord if it is bundled or tangled. If it is used in this manner, it can overheat and fire may be caused.



Do not damage power cord

Do not damage power cord by bending, pulling, or twisting forcibly. It may cause the fire or electric shock. Besides, operating the unit with the something put on the cord may cause overheat, and result in fire.



Never use an explosive or a flammable material with this unit.

Never use an explosive material, a flammable material or a material containing them. An explosion or an electrical shock may result. **ADL311S supports organic solvents by connecting it to the optional GAS410. Carefully read the operation manual of GAS410 and take special care for handling of organic solvents.**

See section “15. List of Dangerous Substances” on page 44.



Never try to touch a hot part.

Some parts of the unit are hot during and immediately after operation. Take special care for possible burning.



Never try to disassemble or alter the unit.

Never try to disassemble or alter the unit. A malfunction, a fire or an electrical shock may result.

1. Safety precautions

Warning · Cautions



Caution



During a thunder storm

During a thunderstorm, turn off the power key immediately, then turn off the circuit breaker and the main power. If this procedure is not followed, fire or electrical shock may be caused.



If the electric failure shall be occurred,

When power is shut off during operation (while the blower is operating or liquid is being sent) due to turning of the ELB to "OFF" or a power failure, all operation modes will reset to the initial states after recovery. When the temperature inside the chamber has been high, keep operating the blower until it cools down to 45°C or below after recovery from a power failure.



Do not perform unattended operation during activating the unit

Do not perform unattended operation during activating the unit. Since the unit is in idling status and the nozzle is blocked or after the operation using sample, the temperature around outlet is increased and the remaining sample is flown from the sample tube disconnected from the unit, and this failure may cause the indeterminism accident.



About countermeasures against static electricity

The cyclone may charge with static electricity depending on the specific specimen used, or operating environment or conditions. Implement countermeasures against static electricity such as attaching included earth clips at three positions on the clamp at the connection of the cyclone or attaching an antistatic brush (optional) to the body of the cyclone.

2. Before using this unit

Precautions when installing the unit

Warning

1. Always ground this unit



- Be sure to connect the earth wire (the green cable of power cord) to the grounding conductor or ground terminal to prevent accidents caused by electric leakage.
- This unit requires a single phase 220V power supply (also supports AC200V or AC240V by selecting either of it) (See page 11 (1)) Ask the nearest electrical contractor for the power including the connecting work. The setting (connecting) work is performed following the related electrical equipment technical standard published by the corresponding country to be used this unit.
- Do not connect the earth wire to gas or water pipes. If not, fire disaster may be caused.
- Do not connect the earth wire to the ground for telephone wire or lightning conductor. If not, fire disaster or electric shock may be caused.

Rounded terminal for M4

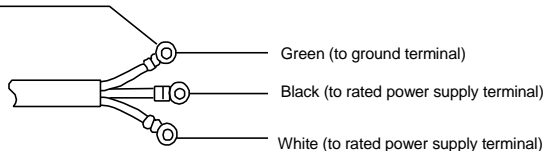

- The power plug is not attached as standard component. Connect the earth correctly adjusting the type of the power equipment of the user.

2. Pay attention to the color of each core wire when connecting the power cord



Be sure to check that the breaker on the power source equipment side is turned "OFF" when connecting power cord without fail. Note that the ADL311 does not attach the power plug as standard component. Select the appropriate power plug and terminal matching to the power capacity of the power source equipment to be connected, and connect them.

| Core Wire Color | In-house Wiring |
|-----------------|-----------------|
| Black | Voltage Side |
| White | Voltage Side |
| Green | Ground Side |

3. Choose a proper place for installation



Do not install this unit in a place where:

- Rough or dirty surface.
- Flammable gas or corrosive gas is generated.
- Ambient temperature below 5°C or above 30°C.
- Ambient temperature fluctuates violently.
- There is direct sunlight.
- There is excessive humidity and dust.
- There is a constant vibration.
- Place where the water is easy-to-be splashed.



Install this unit on a stable place with the space as shown below.

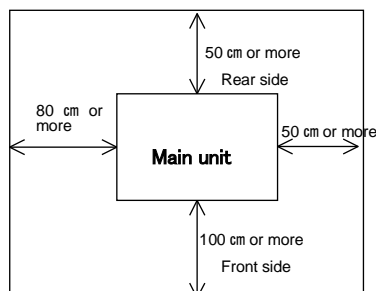

Before using this unit

Precautions when installing the unit

Warning

4. Do not use this unit in an area where there is flammable or explosive gas



- Never use this unit in an area where there is flammable or explosive gas. This unit is not explosion-proof. An arc may be generated when the power switch is turned ON or OFF, and fire/explosion may result.



Refer to page 44 "15. List of Dangerous Substances".

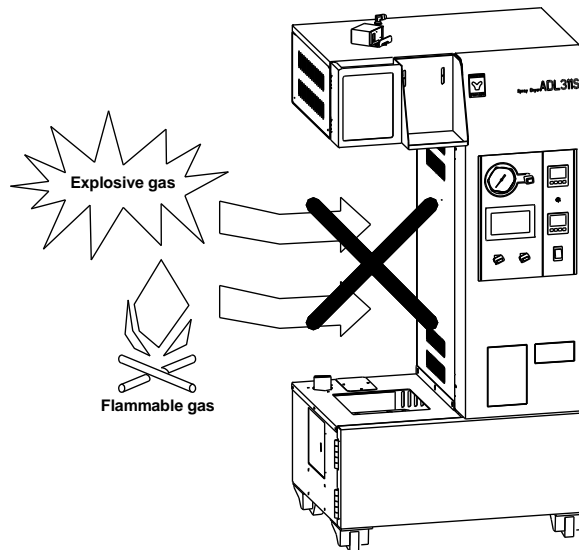

5. Do not use explosive or flammable substances



- Never use explosive substances, flammable substances and substances that include explosive or flammable ingredients in this unit. Explosion or fire may occur. **ADL311S supports organic solvents by connecting it to the optional GAS410. Carefully read the operation manual of GAS410 and take special care for handling of organic solvents.**

Refer to page 44 "15. List of Dangerous Substances".

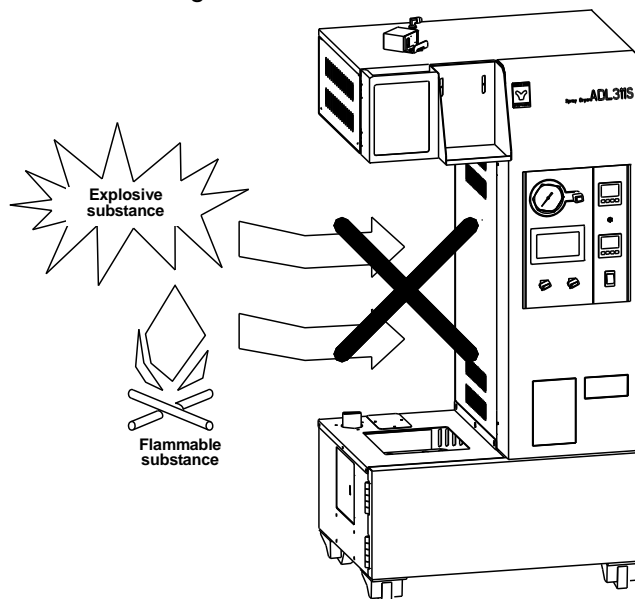

2. Before using this unit

Precautions when installing the unit

Warning

6. Do not modify

-  Modification of this unit is strictly prohibited. This could cause a failure.

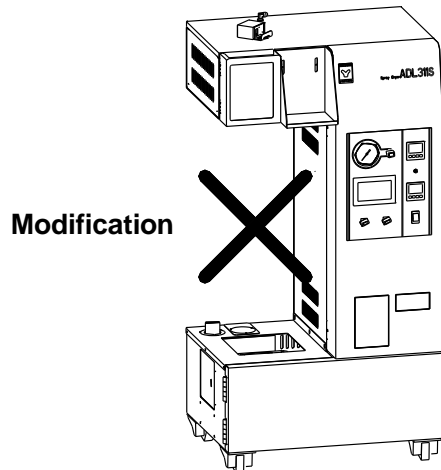

7. Do not topple or tilt this unit

-  Set this unit to the flattest place. Setting this unit on rough or slope place could cause the vibration or noise, or cause the unrespectable trouble or malfunction.

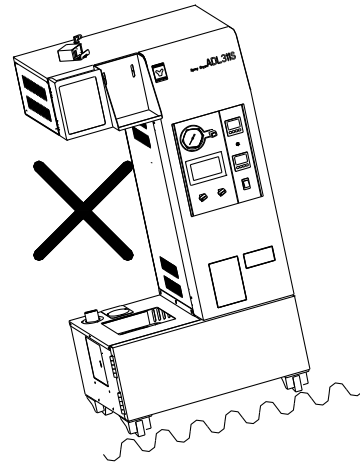

8. Use specified receptacle for power source

-  Choose a correct power distribution board or receptacle that meets the unit's rated electric capacity.



Electric capacity: AC220V Single phase 17A (AC200V Single phase 16A, AC240V Single phase 18A)

The specification has set to 220V at the time of factory shipping. If you want to switch to AC200V or AC240V power supply, first change the terminal position in the unit before connecting a power supply. (See " Before Using this unit " on P.11)

There could be the case that the unit does not run even after turning ON the power. Inspect whether the voltage of the main power is lowered than the specified value, or whether other device(s) uses the same power line of this unit. If the phenomena might be found, change the power line of this unit to the other power line.

For connecting of the device to the power source, ask the dealer that you purchased this unit from or an electrical contractor for safe.

9. Handling of power code

-  Do not entangle the power cord. This will cause overheating and possibly a fire.
Do not bend or twist the power cord, or apply excessive tension to it. This may cause a fire and electrical shock.
Do not lay the power cord under a desk or chair, and do not allow it to be pinched in order to prevent it from being damaged and to avoid a fire or electrical shock.
Keep the power cord away from any heating equipment such as a room heater. The cord's insulation may melt and cause a fire or electrical shock.
-  If the power cord becomes damaged (wiring exposed, breakage, etc.), immediately turn off the power at the rear of this unit and shut off the main supply power. Then contact your nearest dealer for replacement of the power cord. Leaving it may cause a fire or electrical shock.
Connect the power plug to the receptacle which is supplied appropriate power and voltage.

2. Before using this unit

Service receptacle capacity

Service receptacle capacity



Apply the 220V 2A or less service receptacle for this unit.

Connecting the service receptacle with its capacity over 2A blowouts the fuse, and the power source to the service receptacle is shut down. For resetting this damage, replace the fuse in the fuse holder on the right side of the back of the unit.

Applicable models

Mag mixer: MA series, M-21, MD series, MC800, MF800

Laboratory stirrer: LT series, LR series, LS series

Use a separate power supply for a unit with a heater and its total current exceeds 2A

Temperature output terminal

The temperature output signals for the Outlet (outlet temperature) and the Inlet (inlet temperature) are 4-20mA for the measure temperature of 40-240°C.

[Current output of 4-20mA : Measured temperature of 40-240°C]

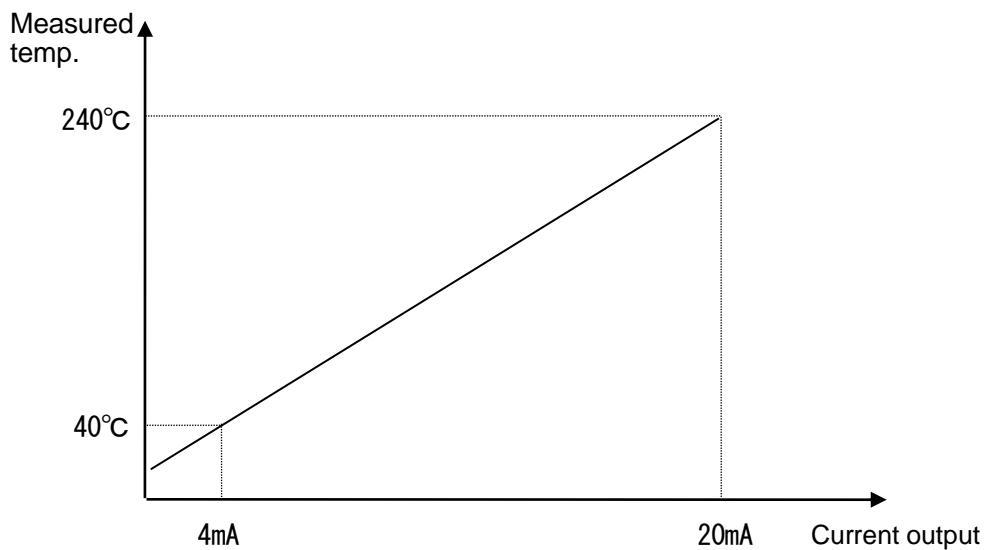

Conversion formula: Current output I (mA) = 0.08 x (measured temperature T(°C) + 10)

Measured temperature T(°C) = 12.5 x current output I (mA) - 10

When you connecting to the voltage input of the recorder, connect a fixed resistor (shunt resistor) of 600Ω or lower to the voltage input of the recorder.

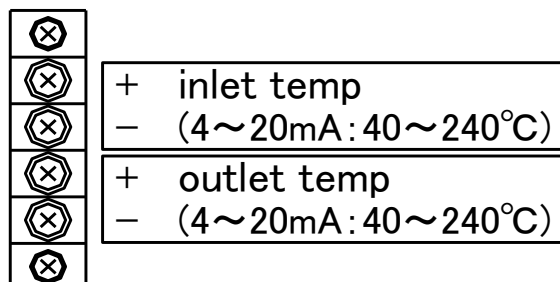

3.Names of parts and their function

Main unit + GF300 set

Front side

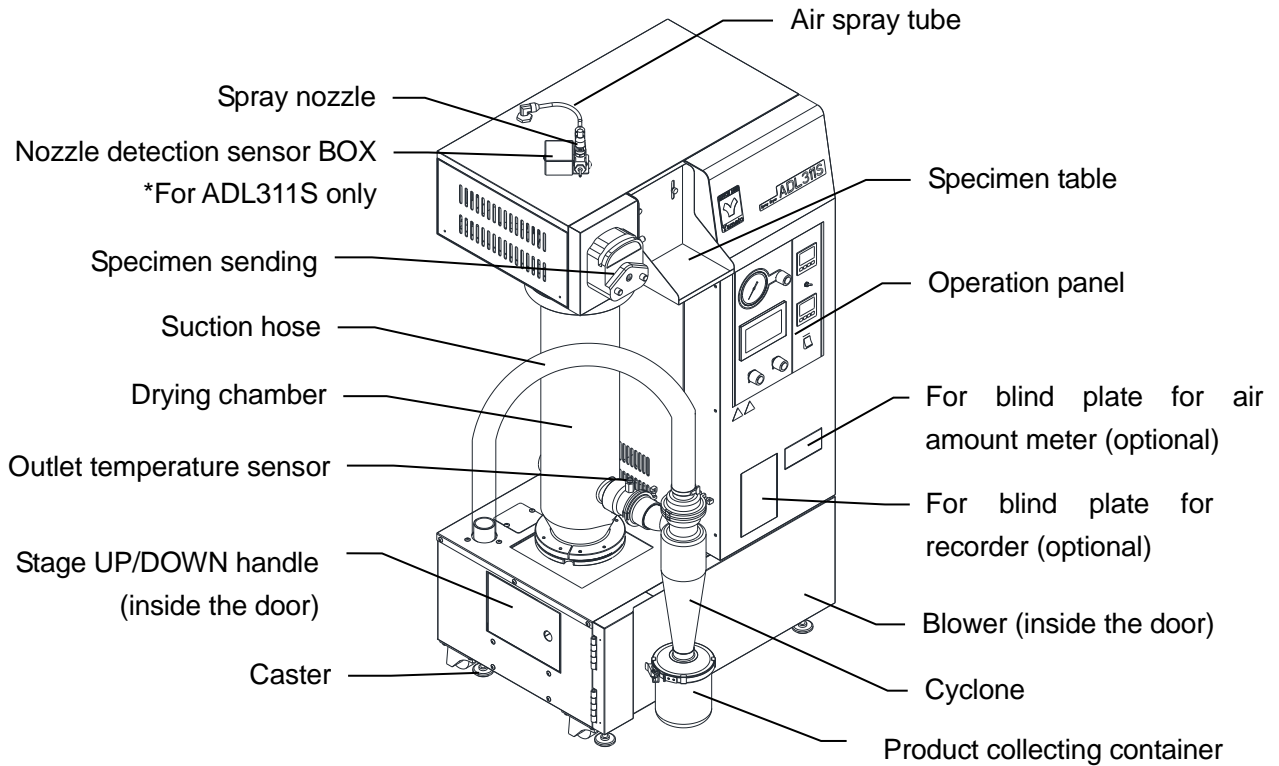

Rear side

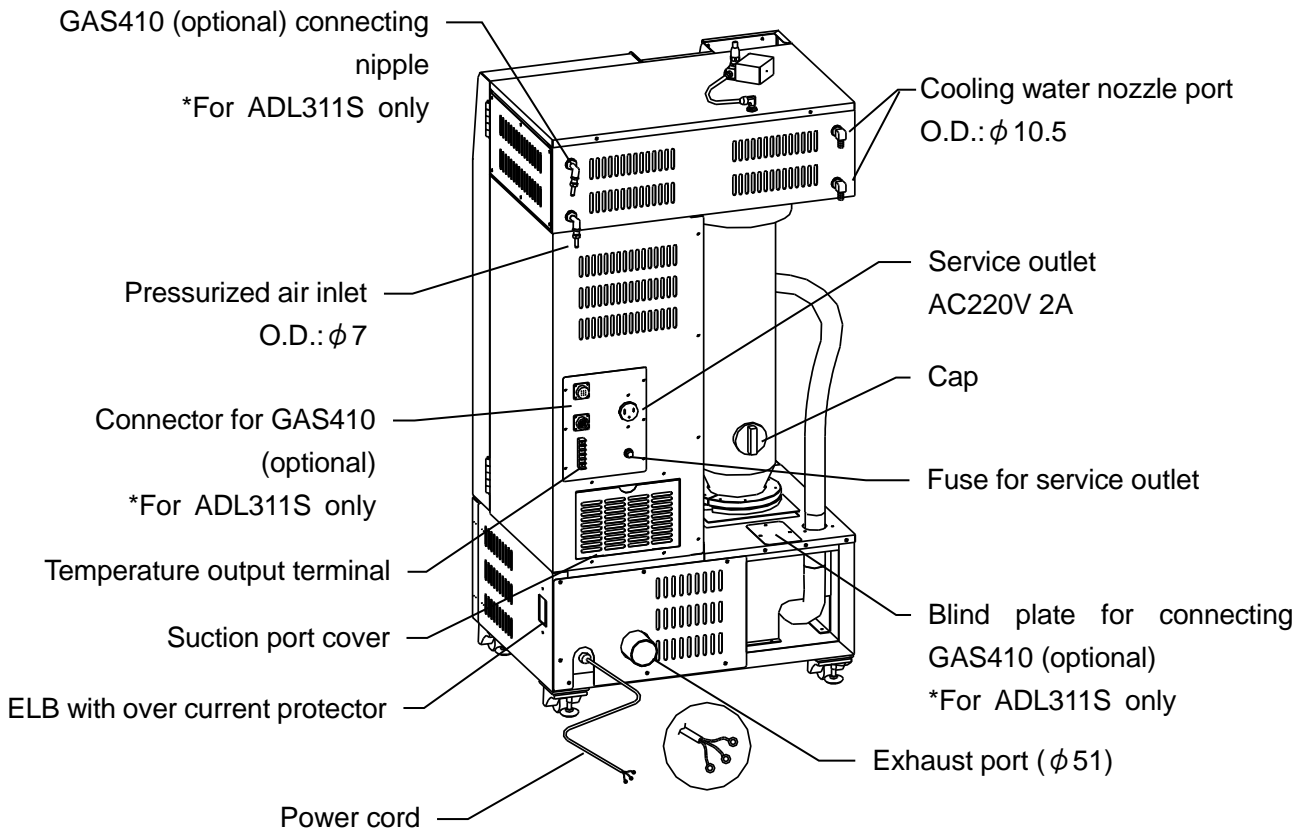

3.Names of parts and their functions

Operation panel

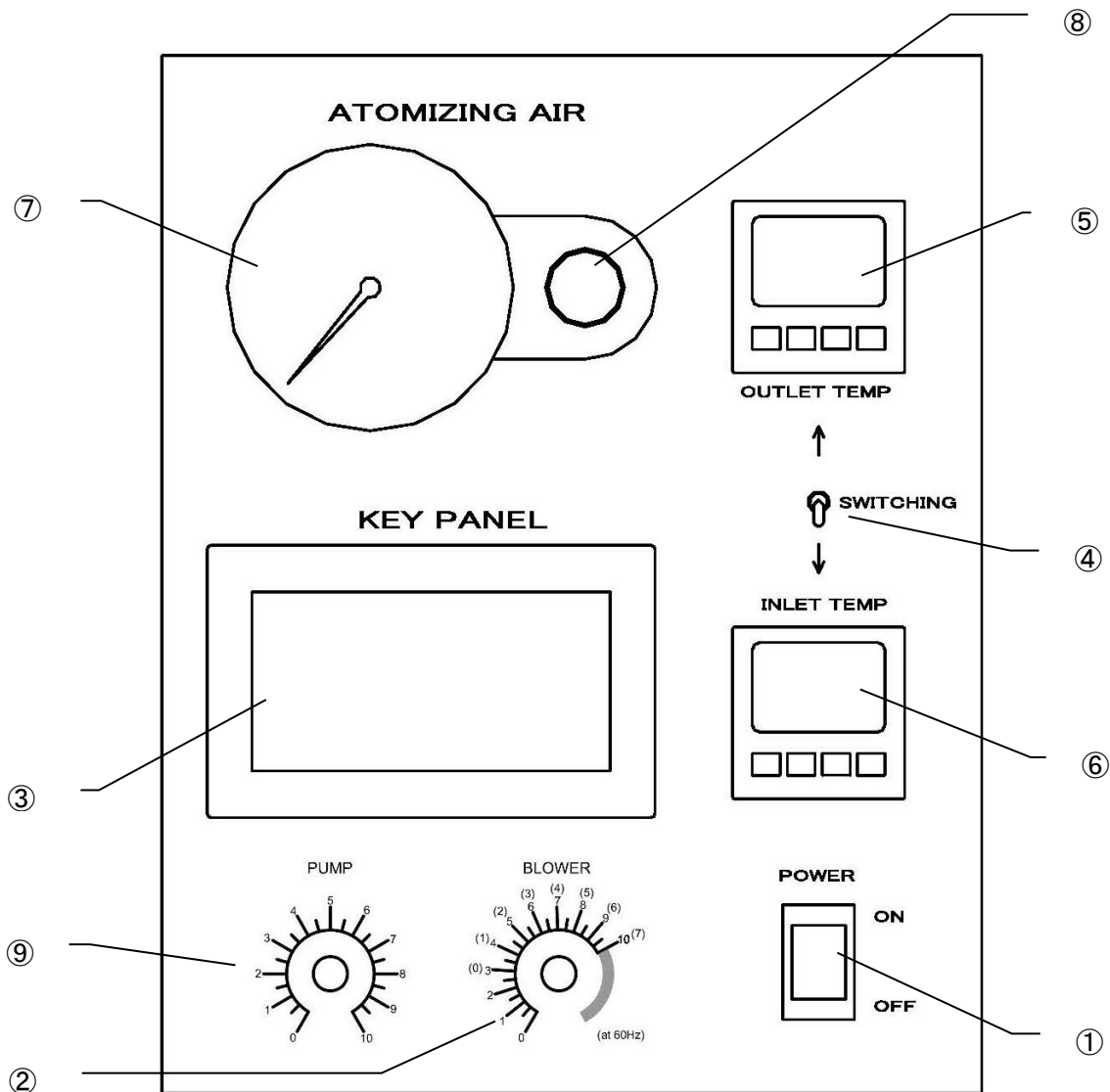

| No. | Name | Operation/action |
|-----|---|--|
| ① | Power switch | This is used to turn power ON/OFF. |
| ② | Blower control dial | This is used to set an air amount. |
| ③ | Key panel (Touch panel) | This is used to perform the operations below and display. Blower ON/OFF, liquid pump FORWARD/REVERSE Heater ON/OFF, pulse jet switch, error indication |
| ④ | Control selector switch | Set temperature on the temperature controller on the selected side is used to control the temperature. |
| ⑤ | Setting and display of outlet temperature | This is used to set an outlet temperature, display the measured temperature and as an overheat preventive device. |
| ⑥ | Setting and display of inlet temperature | This is used to set an inlet temperature, display the measured temperature and as an overheat preventive device. |
| ⑦ | Pressure meter | This meter indicates the pressure of pressurized air. |
| ⑧ | Needle valve control dial | This dial is used to control pressure of pressurized air. |
| ⑨ | Liquid sending speed control dial | This dial is used to control flow of the liquid pump. |

4. Operating procedures

Preparations

(1) Selecting the power supply

! First switch the power supply terminal

First check that the switches of the control assembly and the ELB are OFF and then connect the power cord securely to the power supply meeting the specified voltage and current.

Ordinary, the unit has been specified to AC220V. Switch the terminals in the unit before connecting the power supply when you are going to use the unit in an AC200V or AC240V district. The terminal block is located inside the door at the front control assembly.

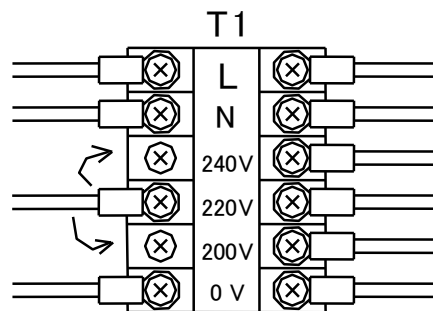

(2) Connecting an earth

The power cord of this unit is an earthed 3-core captive cable (VCT) that integrates an earth wire and you must earth the green wire.

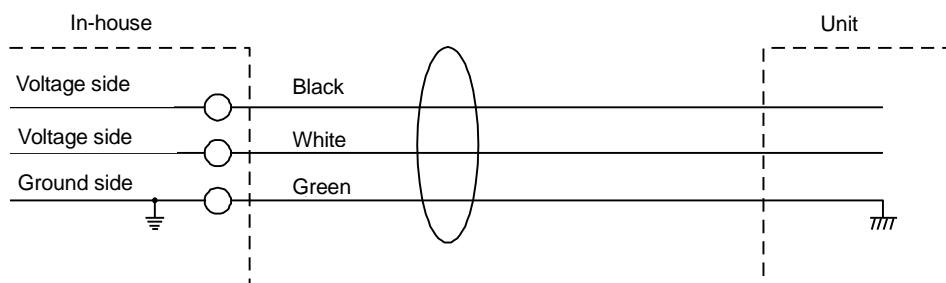

(3) Connection of the exhaust duct

In an environment where hot air or fine particles from the blower are of concern, connect the included exhaust duct to the exhaust port and use a draft chamber to exhaust them to outside.

4. Operating procedures

Preparations

- (4) Connect the nipple ($\phi 7$) at the rear of the upper frame and the compressor or other pressurized air units with the included pressure-proof hose and then securely tighten it using a hose band. Adjust the discharge pressure of the compressor to be constant (0.3MPa or less) using the pressure reducing valve.

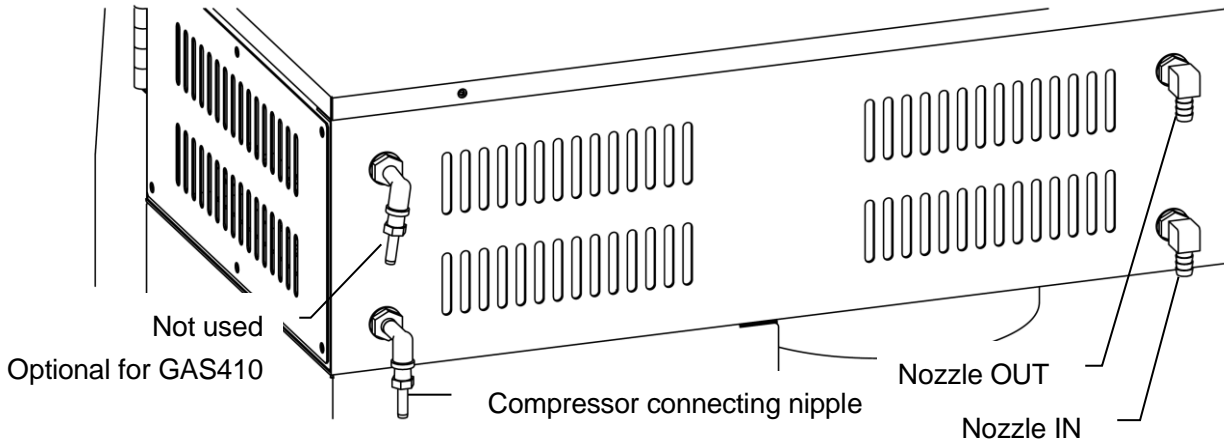

- (5) Cooling the spray nozzle
The cooling mechanism for the spray nozzle is pre-installed (nozzle O.D.: $\phi 10.5$). When you operate the unit under operating conditions under which the spray nozzle is likely to clog, connect a separate cooling water circulating unit (such as CF300) or to a tap water faucet to allow cooking water circulating.
- (6) Open the package of the mini spray attachment (GF300) and check for damages to glass and other parts or any missing parts.
- (7) Install the distributor and aluminum honeycomb assembly onto the top of the unit.
Install the O-ring P16 into the $\phi 20$ groove on the top of the distributor.
(install using three M6 x 20 hex bolts, spring washers, flat washers each)

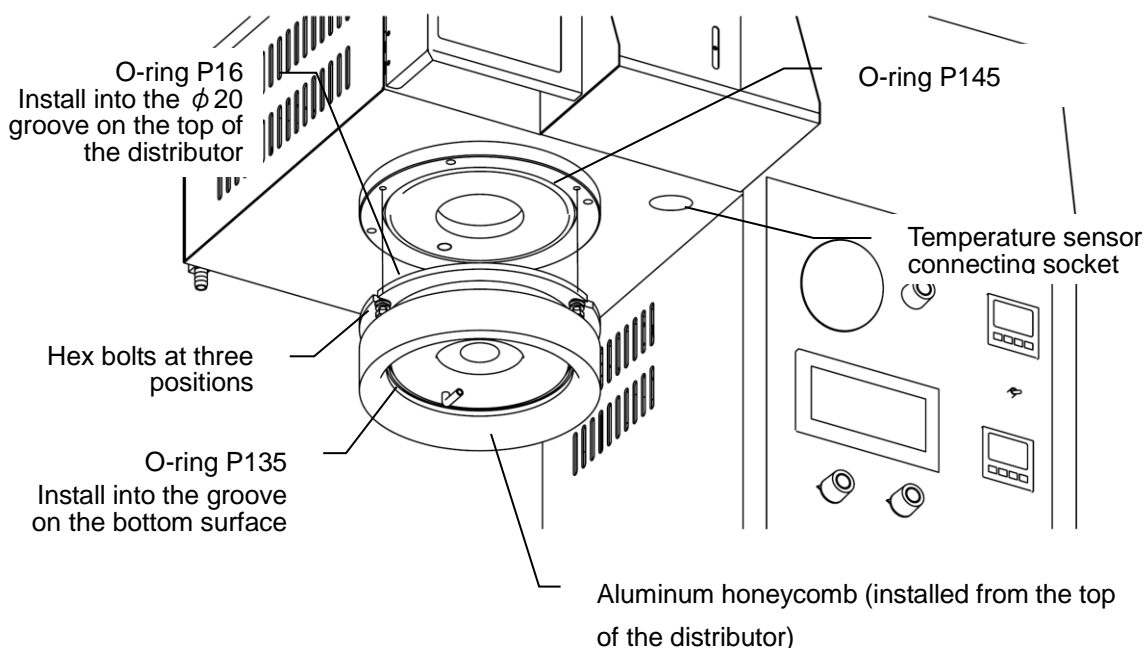

4. Operating procedures

Preparations

- (8) Insert the pipe in the center of the distributor and twist it all the way.

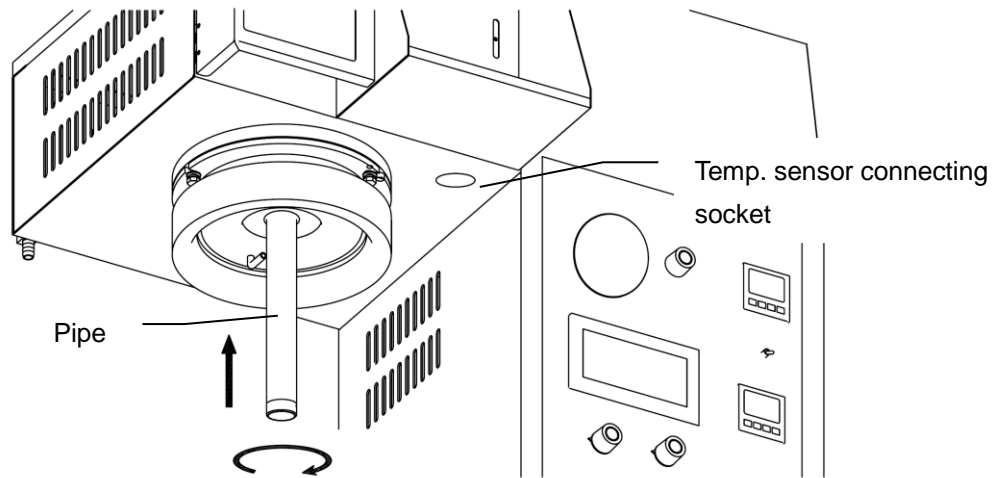

- (9) Align the groove with the stage positioning pin and then install the drying chamber.
Open the left side door and turn the handle while holding the drying chamber by hand to lift the stage. When the glass chamber reaches the top of the main unit, turn the handle by about half a rotation from that position and then securely fix the glass chamber.

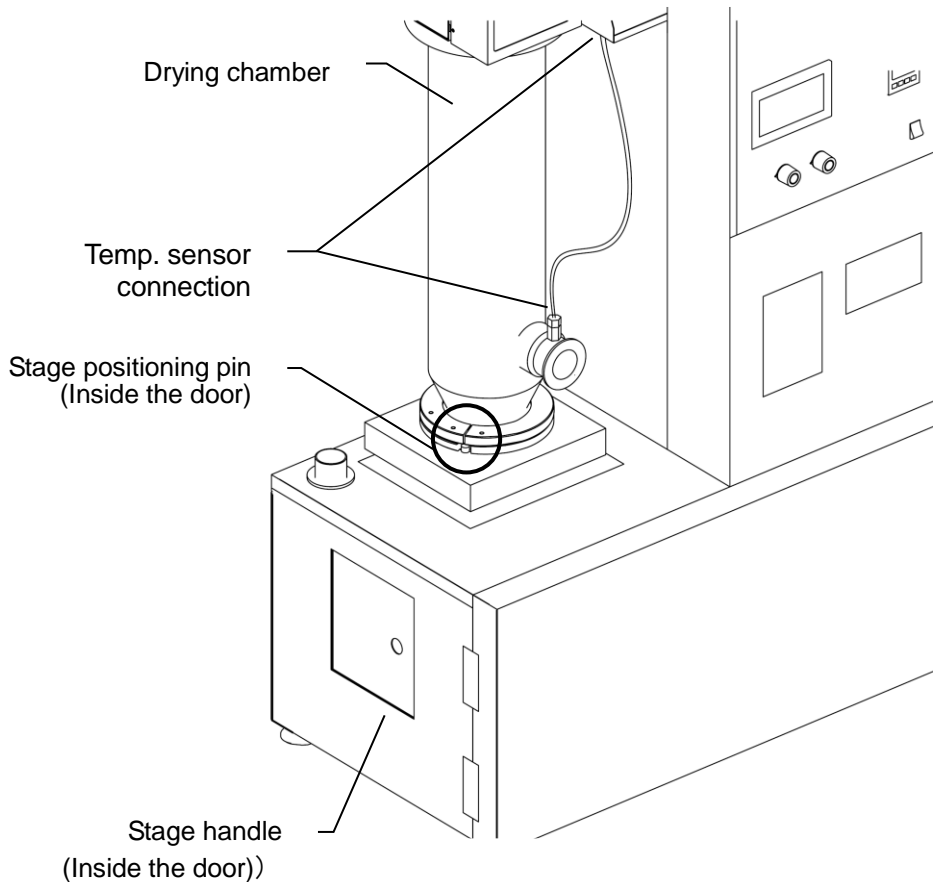

- (10) Install the outlet temperature sensor into the pipe at the glass container connecting port and insert the plug into the socket on the top of the main unit.

4. Operating procedures

Preparations

(11) Connect the cyclone following the step numbers below.

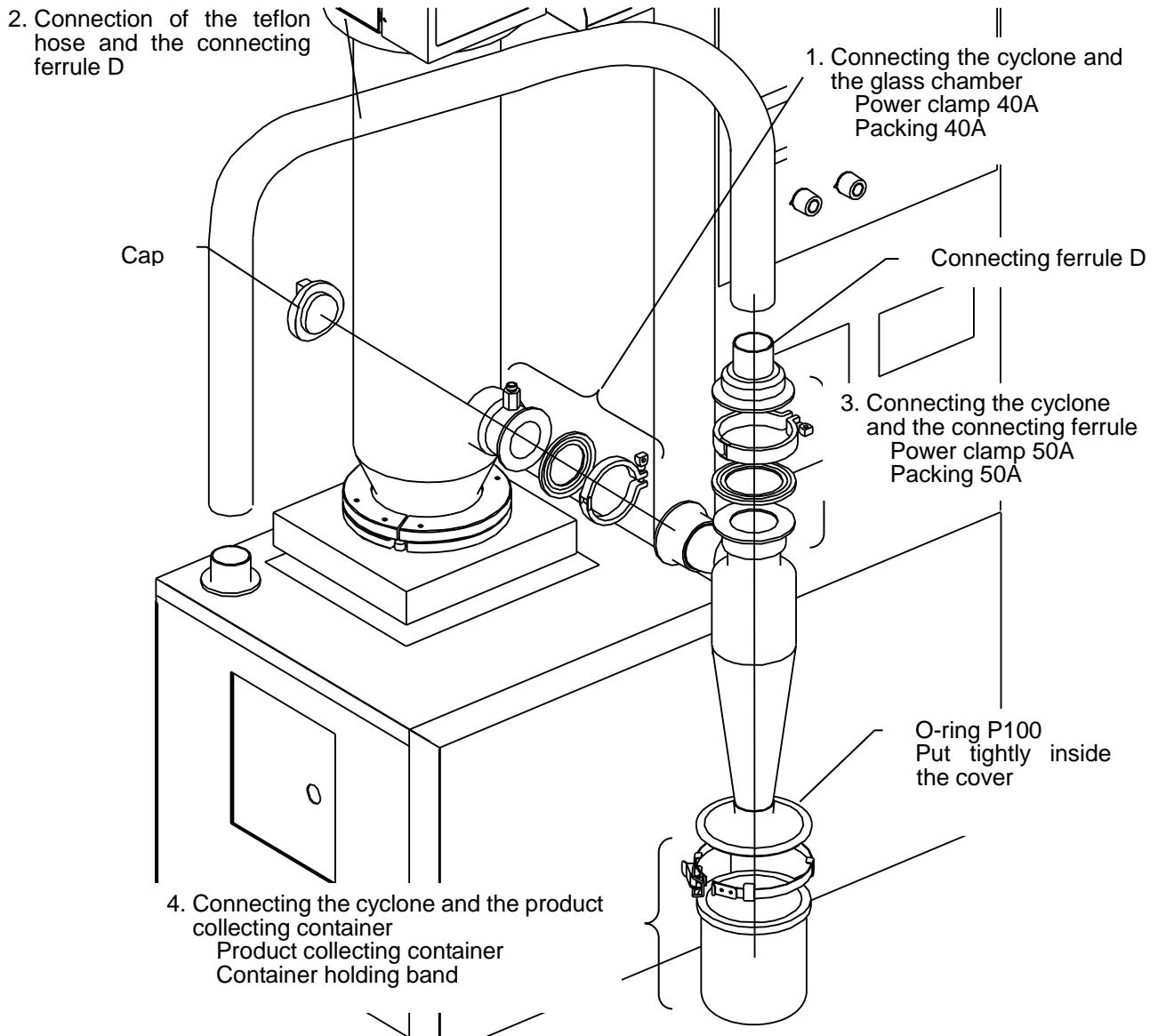

4. Operating procedures

Operating method

Please refer to the sample operating method below that uses settings for a standard sample.
Sodium chloride water solution NET 100g Solid content density:5wt%

- (1) Turn the ELB on the right side of the main unit ON.

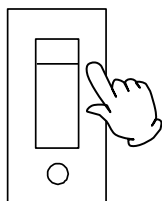

- (2) Turn the **power switch** on the operation panel of the main unit ON.

Temperature controllers, indication lamps, and the key panel will be displayed.

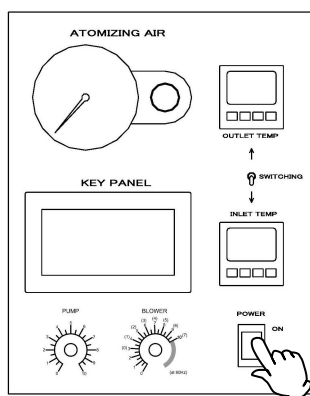

- (3) The temperature controller at the upper part of the control panel is used for outlet temperature while the control at the lower part is used for indicating inlet temperature and temperature setting.

You select temperature control for inlet or outlet temperature using SWITCHING. When you want to control temperature by the outlet temperature, select inlet temperature at the start of operation switch to outlet temperature once the temperature has stabilized.

*Setting ranges will differ among temperature controllers.

Outlet temperature setting range:0 to 60°C

Inlet temperature setting range:0 to 220°C

Example: Select the inlet side with SWITCHING

Inlet temperature setting: 150°C

- (4) Install the mini spray attachment following the procedures above (P.12~P.14).

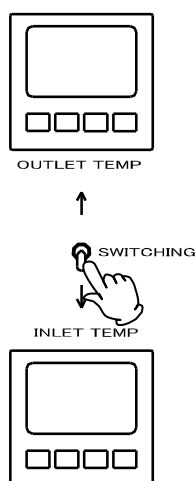

4. Operating procedures

Operating method

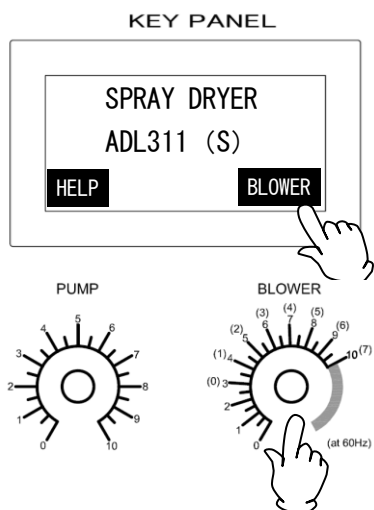

- (5) Turn the blower switch ON and set air amount.

Example: Air amount 0.45m³/min

(See "Dry air amount correspondence table" on P.20.)

*Use HELP key to move to the manual/language select screen, confirm the operation manual of the unit, and then you can select the OSD language (English, Japanese, Chinese).

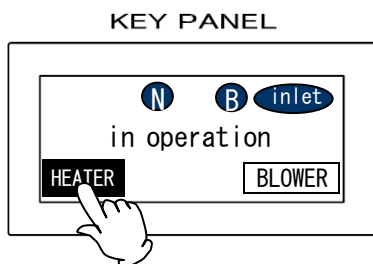
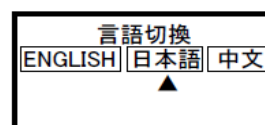
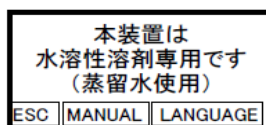

- (6) Turn the heater switch ON.

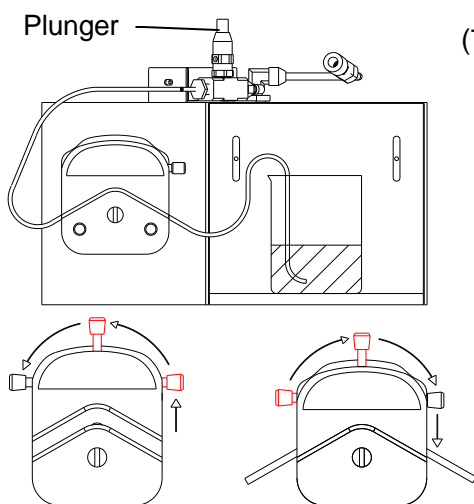

- (7) Set the liquid tube as shown in the left diagram. Push the pump rod CCW to open the pump head, put the liquid sending tube in it, and then push the rod CW to have the tube stuck. Set distilled water as the specimen.

Example: Specimen of distilled water set

* When specimen is not sprayed any more, it is suspected that the orifice of the spray nozzle is clogged, which can be cleared by pressing the plunger at the upper part of the nozzle (P25. "Cleaning After Using" Exploded view of the spray nozzle). The needle (P25. "Cleaning After Using" Exploded view of the spray nozzle) pushes out the clog in the orifice.

4. Operating procedures

Operating method

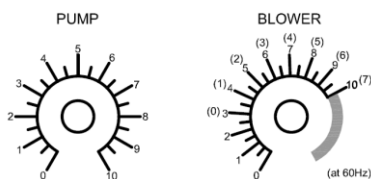
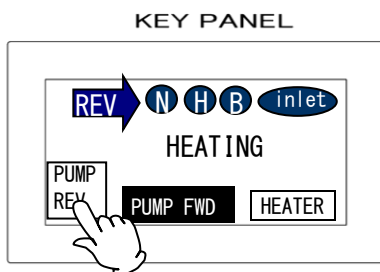
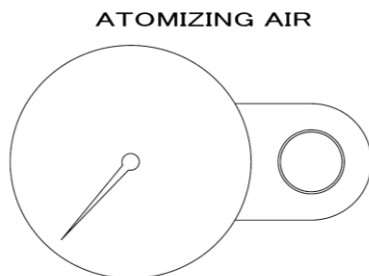
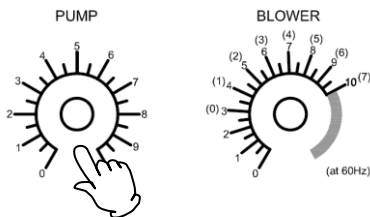
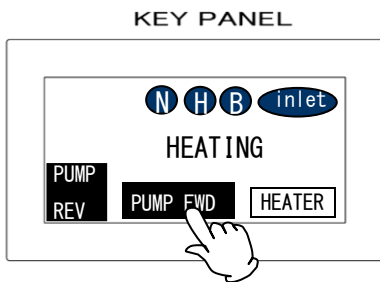
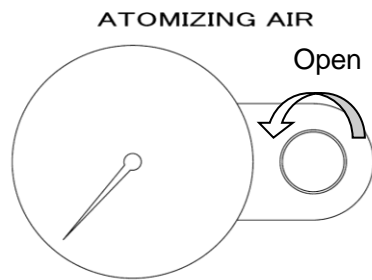

- (8) When the inlet and the outlet temperatures have reached the temperatures you want, set the spray pressure, turn the pump FWD switch ON and send distilled water.

Example: Set the spray pressure to 0.1MPa when the outlet temperature has risen to around 80°C. Adjust liquid sending speed so that the outlet temperature will be slightly lower than about 75°C.

- (9) Readjust dry air amount, spray pressure, and liquid sending speed so that the inlet and the outlet temperature will be stable at the temperatures you want.

Example: Adjust liquid sending speed so that the outlet temperature will be stable at around 75°C or slightly lower temperature.

~Hint~

- Influences below are of specific settings on the outlet temperature when the inlet temperature is constant.
 - Sent specimen liquid amount
 - small : outlet temperature →high
 - Dry air amount
 - large : outlet temperature →high
 - Specimen density (external factor)
 - high : outlet temperature →high
- Drops of sprayed liquid will become fine at a higher spray pressure.

4. Operating procedures

Operating method

- (10) When the outlet temperature has become stable, change the specimen with the actual one. At this time the outlet temperature will change slightly and adjust liquid sending speed again when necessary.

Example: Change specimen to 100g of 5% sodium chloride solution

Finishing process

- (11) When specimen has been sent, change the specimen back to distilled water and clean inside the nozzle. Clean inside the nozzle for about five minutes, turn the pump FWD switch OFF, and then choke the spray pressure to 0.

Example: When processing of 100g has finished after about 15minutes, change the specimen to distilled water.

ATOMIZING AIR

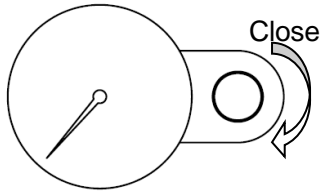

KEY PANEL

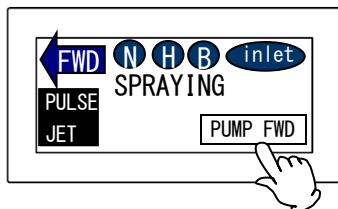

KEY PANEL

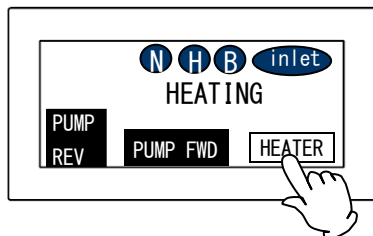

KEY PANEL

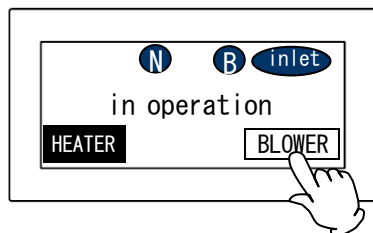

POWER

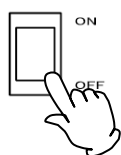

- (12) Turn the heater OFF, wait until the outlet temperature drops to 45°C or less, and turn the blower OFF.

* **To avoid a malfunction, do not allow the blower operation stopping with the outlet temperature at 45°C or over.**

- (13) Turn the power switch OFF.
(14) Remove the container holding band and take out the product collecting container. When taking out the container, take care the powder attached on the back side of the cyclone cover.

Example: Amount of collected powder will be about 3 to 3.5g.

- (15) Wash the containers according to the maintenance method (P25. "Cleaning After Using").
* **When you used a sample such as sodium chloride that corrodes metals, disassemble the spray nozzle and wash thoroughly.**







4. Operating procedures

Operating method

KEY PANEL Description of indication lamps

You can confirm the operating statuses of switches on the KEY PANEL by checking whether a specific lamp is on or off.

Each lamp will be turned on at the upper right corner on the KEY PANEL.

| | |
|---|--|
|  | Lamp on: Indicates that the spray nozzle is attached. Lamp blink: Indicates that a spray nozzle is not attached. |
|  | You can control temperature by setting a temperature on the outlet side temperature controller while the lamp is on. |
|  | You can control temperature by setting a temperature on the inlet side temperature controller while the lamp is on. |
|  | When the lamp is on, the blower is in operation. |
|  | When the lamp is on, the blower is in operation. |
|  | When the lamp is on, the liquid sending pump is operating in the normal direction. |
|  | When the lamp is on, the liquid sending pump is operating in the normal direction. |

When you want to abort processing of the sample, or when the nozzle is clogged

Abort sending liquid following operations of the ending process (P18 (8) to (12)) when you want to abort processing of the sample or the nozzle is clogged.

And if you want to process another sample, recover contents in the product collecting container, clean it according to the maintenance method (P25. "Cleaning After Using"), and then operate the unit using another sample.

4. Operating procedures

The relation between adjustment scale of liquid sending pump and liquid amount/between adjustment scale of blower and dry air amount (reference)

The corresponding table as below is for each scale value of liquid sending pump and average liquid sending amount (the calibration liquid is water at 23°C).

Operation reference. Please pay attention that the density and viscosity of solution have influence on the liquid sending amount. If the liquid sending amount is less, the liquid sending pump head may be not compressed tightly, or there is block or damage for the liquid sending hose.

| Scale value of liquid sending pump | Avg. liquid sending amount (ml/min) |
|------------------------------------|-------------------------------------|
| 0 | 0 |
| 1 | 1.4 |
| 2 | 5.2 |
| 3 | 8.2 |
| 4 | 11.3 |
| 5 | 14.4 |
| 6 | 17.7 |
| 7 | 20.7 |
| 8 | 23.9 |
| 9 | 27.4 |
| 10 | 29.2 |

The following is the reference table for each dial value of the blower and average flow rate of the drying air. Refer to the value for the guideline of the work. If air amount is too low, the blower filter or the suction filter may be clogged. Clean the filter according to the maintenance method (see P.25). Besides, since the flow rate of the drying air for each dial is differed depending on the frequency of the power source, 50Hz or 60Hz, pay attention to this point.

| In the case of 200V/50Hz power source | |
|---------------------------------------|---|
| Blower dial value | Average flow rate of drying air (m ³ /min) |
| 0 | 0.12 |
| 1 | 0.14 |
| 2 | 0.27 |
| 3 | 0.38 |
| 4 | 0.46 |
| 5 | 0.53 |
| 6 | 0.59 |
| 7 | 0.65 |
| 8 | 0.71 |
| 9 | 0.75 |
| 10 | 0.78 |

| In the case of 200V/60Hz power source | |
|---------------------------------------|---|
| Blower dial value | Average flow rate of drying air (m ³ /min) |
| 0 | 0 |
| 1 | 0 |
| 2 | 0 |
| 3 (0) | 0 |
| 4 (1) | 0.07 |
| 5 (2) | 0.16 |
| 6 (3) | 0.31 |
| 7 (4) | 0.41 |
| 8 (5) | 0.49 |
| 9 (6) | 0.57 |
| 10 (7) | 0.64 |

5. Handling Precautions



1. Substances that cannot be used



Never use an explosive, a flammable, or a substance that contains them. Otherwise, an explosion or a fire may result. **ADL311S supports organic solvents by connecting it to the optional GAS410. Carefully read the operation manual of GAS410 and take special care for handling of organic solvents.**

See P.44 "15. List of Dangerous Substances".

2. If a problem occurs



If smoke or strange odor should come out of this unit for some reason, turn off the power key right away, and then turn off the circuit breaker and the main power. Immediately contact a service technician for inspection. If this procedure is not followed, fire or electrical shock may result. Never perform repair work yourself, since it is dangerous and not recommended.

3. Do not touch the part with high temperature



The chamber, cyclone, and peripheral part become high temperature during and just after operation. Do not touch these parts, for there may be caused heat injury.

5. Handling Precautions



1. Do not put anything on this unit



Do not put anything on this unit. It will cause injury if fall.

2. During a thunder storm



During a thunderstorm, turn off the power key immediately, then turn off the circuit breaker and the main power. If this procedure is not followed, fire or electrical shock may be caused.

3. Do not use corrosive sample



Stainless steel SUS304 is used for the interior; however, it may be corroded by strong acid etc.. In addition, the sealing strip and silicon rubber may be corroded by some kind of solvent like acid, alkali, oil, halogen, etc.. Do not use the sample containing those substances.

4. Recovering after power failure



When power is supplied after a power failure, the device automatically starts operation again with the same state as just before the power failure.

5. After installing



It may cause injure to a person if this unit falls down or moves by the earthquake and the impact, etc.. To prevent, take measures that the unit cannot fall down.

6. Do not disassemble glassware and pipes when the inlet or outlet temperature is above 45°C.



Do not disassemble glassware and pipes when the inlet or outlet temperature is above 45°C. Otherwise, burns will occur.

The heating pipe inside the machine expands in size at high temperatures. At this time, if disassemble the glassware and pipes for cleaning, the glassware and pipes will shrink due to cold, and the size of interface will be smaller. The size mismatch will occur when they are re-installed, and the forced installation will cause damage.

5. Handling Precautions

Drying Method under Appropriate Condition

- (1) The best appropriate drying condition is differed depending on the sample to be dried. Inquire the data for the partial example of various samples.
- (2) Adjust the drying condition so as to match to the various errors to be possible to occur such as too much adhesion of the sample to the drying chamber, too high density of the sample, too low temperature around inlet, too high or too low pressure of spray air, too much feeding amount of sample.
- (3) When the spray direction is changed by the adhesion of the sample to the spray nozzle during operation, turn "ON" the pulse jet switch, and blowout the adhesive from the tip of the nozzle using pressurizing air. Even though the adhesive is not blowout, dismount the spray nozzle, and clean the tip of the nozzle using the soaked paper in water.
- (4) The possible cause for adhesion of the sample to the cyclone part is either not evaporating the solvent (distilled water or ion-exchanged water) with enough or the property of the sample itself (low melting point, absorption, etc.).

For depleting the powder, increasing the amount of heat for sample is the best measure. Therefore, perform either measure below, to increase either temperature around inlet or flow rate of the drying air, or to reduce the feeding amount of the sample, that is, to reduce the difference between the temperature around inlet and that around outlet. When the reason is in the property of the sample itself, adjust the sample by adding the special additive, etc.

- (5) In the case that the hygroscopicity is high, the product may become the moist powder in the container. Change the drying condition following the method in (4), or, if required, heat up the container for product before operation.
- (6) The orifice of the spray nozzle is 460 μ . If the sample is blocked with suspension at orifice part impetuously, use the 508 μ and 711 μ nozzles prepared for the orifice as optional (Nozzle main body P25. "Cleaning After Using", the nozzle main body, the needle, and the ring in the exploded view of the spray nozzle are common with the 406 μ nozzle) These 508 μ and 711 μ nozzles are differed on the point of the size of the spray pattern and particle diameter of the drop slightly compared to the 406 μ one, and these differences may affect the interference status. Refer to the Graph 1 for the relation between spray air pressure and spray airflow rate (atmospheric conversion).

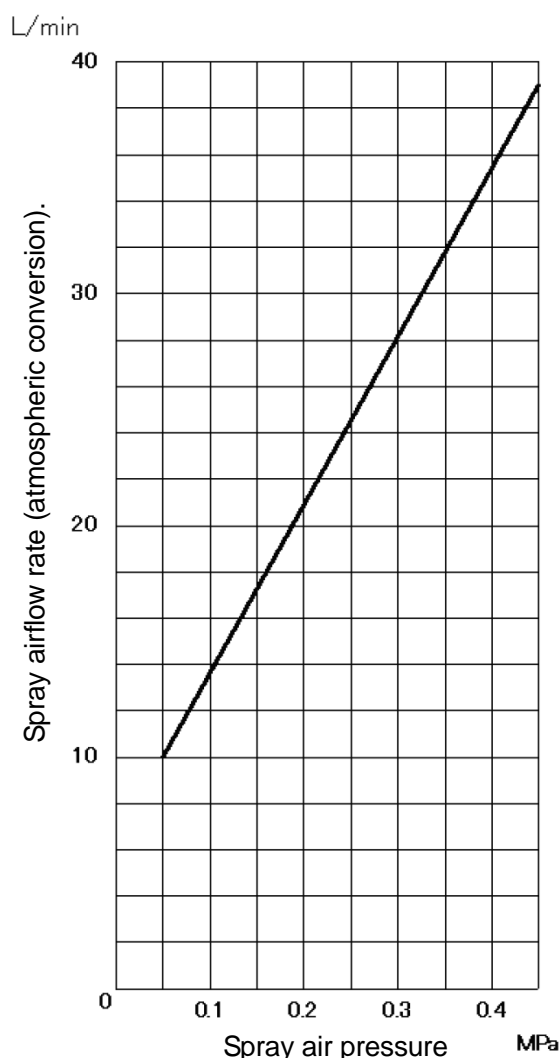

Graph 1

- (7) The too small powder (few μ or less) among dried ones is impossible to be collected, and exhausted to the outside through the blower. If this exhausted amount of the too small powder becomes more, decrease either spray airflow rate or spray air pressure. Also, since the particle diameter becomes smaller as the density of the sample is lower, adjust the density of the sample if required.

5. Handling Precautions

Caution during operation

- (1) Never fail to connect the earth wire when connecting the power supply.
- (2) Connected to pressurized air pressure of 0.3MPa following.
- (3) Do not heat up the temperature around outlet over 100 Celsius degree, for the material of the suction/exhaust hose, material of the filter, and performance of the blower may be deteriorated. The heater will stop automatically when the temperature exceeds 110°C.
- (4) Check the glass chambers are fixed to the specified position with no gap, and then turn on the switches of blower and heater.
- (5) The unit is not explosion proof. Do not use any solvent that contains flammable organic solvents for the specimen. ***When you use an organic solvent for ADL311S, connect the optional (GAS410) organic solvent collecting unit.**
- (6) When the heater is ON, do not expose the cap and bayonet of the spray nozzle to the non-guard status, and do supply the air to the heater part for at least 0.1 to 0.2m³/min.
- (7) When the sample is not sprayed, the orifice of the spray nozzle is considered as blocked. Press the plunger of the upper nozzle (P25. "Cleaning After Using" spray nozzle exploded drawing) . The needle (P25. "Cleaning After Using" spray nozzle exploded drawing) pushes out the clogging of the orifice. When the specimen accumulated on the nozzle tip in an ice pillar-like form, clean it off using the pulse jet switch on the touch panel.
- (8) If the sample is not fed from the feeding pump, the following causes may be considered; the sample tube is crushed at the roller of the pump, the inner wall of the tube is adhered tightly without restoration, or the inner of the nozzle is blocked. Remove the cause, and reset to the normal status.
- (9) Do not perform unattended operation during activating the unit. Since the unit is in idling status and the nozzle is blocked of after the operation using sample, the temperature around outlet is increased and the remaining sample is flown from the sample tube disconnected from the unit, and these failures may cause the indeterminism accident.
- (10) Sample tube made of silicon is oxidized by halogen solenoid or acid (strong), and may be broken by swelling. Therefore, pay attention to the treatment during operation.
- (11) When the high temperature is set to the temperature around inlet for the operation, supplying too excessive airflow of the blower to the unit may not reach the temperature to the setting one caused by not keeping balance with the heater capacity. To resolve this error, turn down the airflow of the blower, increase the setting temperature, and operate this unit. In the case of performing the operation with its setting temperature be required for increasing, the setting value and actual temperature around inlet are not matched.
The heater will stop automatically when the inlet temperature exceeds 230°C or when the outlet temperature exceeds 110°C.
- (12) If this unit is not operated, turn "OFF" the earth leakage breaker on the back of the unit.
- (13) The cyclone may charge easily with static electricity depending on the specific specimen used, or operating environment or conditions. Implement countermeasures against static electricity such as attaching included earth clips at three positions on the clamp at the connection of the cyclone or attaching an antistatic brush to the body of the cyclone.
- (14) If the leakage is existed between container for product and bracket at lower of the cyclone, the dried powder may be stocked onto the lower of the cyclone without falling into the container for product. Therefore, pay special attention to the unit with the container for product be mounted.
- (15) Since the capacity of the container for product is approx. 750ml, the normal powder can fulfill almost 80% of the container by processing 200 to 250g amounts. If continuing operation more, the collecting efficiency of the powder deteriorates excessively. Stop operation for a while, and take the collected powder out of the container.
- (16) Depending on the sample to be processed, the static electricity may be occurred at cyclone. Therefore, remove the static electricity with the appropriate method. It is efficient that the wire is wounded to the glass portion for grounding, but it is more convenient to use the static electricity remover by setting against the cyclone vertically.

6. Maintenance Method

Daily Inspection and Maintenance

Warning

- Disconnect the power cable from the power source when doing an inspection or maintenance unless needed.
- Perform the daily inspection and maintenance after returning the temperature of this unit to the normal one.
- Do not disassemble this unit.

Caution

- Use a well-drained soft cloth to wipe dirt on this unit. Do not use benzene, thinner or cleanser for wiping. Do not scrub this unit. Deformation, deterioration or color change may result in.



Cleaning After Using

- (1) After completing the operation, remove the attachments following the process "Preparations " on P.11 in reverse order.
- (2) Clean the portion of attachment to which the powder is adhered.
- (3) Flow the distilled water into the sample tube by pressing the pump switch, and remove the contaminant attached to the inner of the part.
- (4) Remove the spray air tube and sample tube from the spray nozzle, and disassemble the nozzle as shown in the Photo 1. After disassembling, clean it using the supersonic cleaner. Remaining the contaminant to the inner of the part may cause the insufficient spray. Therefore, clean it completely.

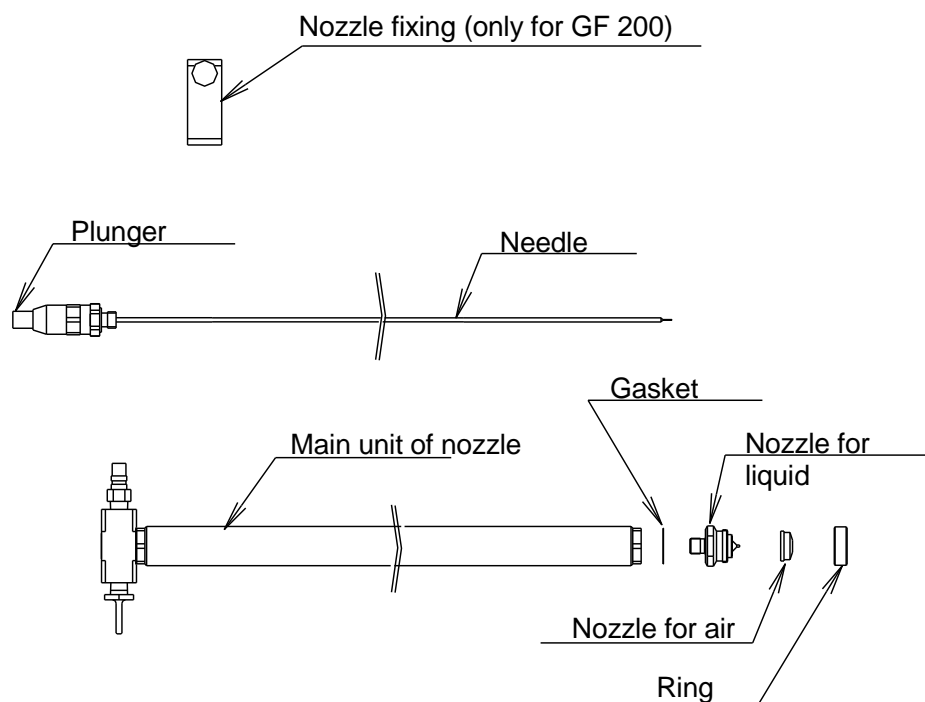

Spray nozzle exploded drawing

6. Maintenance Method

Daily Inspection and Maintenance

Filter Cleaning

- Clean up the filter in blower periodically.
 - 1) Open the door at the bottom of the front surface of the unit, and disconnect the hose from the blower.
 - 2) Open the front cover by removing the two fastening plates for the cover from the upper surface of the blower, and open the front cover, and take the filter out.
 - 3) The followings are the cleaning procedures of the filter.
 - ① Wash the filter pressing in the water repeatedly, and air-dry it.
 - ② Compressed air blowing.
 - ③ Vacuum cleaning with a cleaner.
 - ④ Press washing the filter after being immersed into the solvent that hot water (approx. 40 Celsius degree) and neutral detergent are mixed at a rate of 5:95 one whole day and night, then rinse it with water and air-dry it.
 - 4) When assembling, reversely execute the above procedure. Turn the soft surface of the filter to windward when installing the filter.

- Suction filter

Regularly clean the suction filter.

1. The suction filter is stored in the suction filter case at the rear of the main unit.
2. Clean the suction filter with the same procedures in section 3. above.

Monthly maintenance

- Check the earth leakage breaker function.
 - Connect the power cord.
 - Turn the breaker on.
 - Push the red test switch by a ballpoint pen etc. If there is no problem, the earth leakage breaker will be turned off.

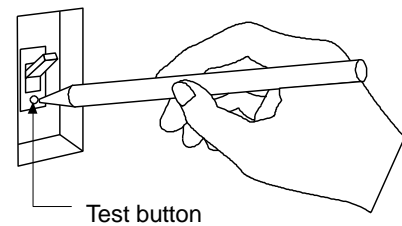

7. Long storage and disposal

When not using this unit for long term / When disposing



Caution

When not using this unit for long term...

- Turn off the earth leakage breaker and original power source for safe without fail. Also, store the glass unit after removing it from the main unit. When the glass unit is contacted to the external, it may cause the breakage.



Warning

When disposing...

- Keep out of reach of children.
- Remove the power cord.

Matters to consider when disposing of the unit

Environmental protection should be considered

- We request you to disassemble this unit as possible and recycle the reusable parts considering to the environmental protection. The feature components of this unit and materials used are listed below.

| Component Name | Material |
|--|--|
| Parts of Main Unit | |
| Casing | Bonderizing steel plate baked with melamine resin coating, Stainless steel |
| Insulating material | Ceramic Felton |
| Specimen bed | Stainless steel |
| Production plates | Polyethylene (PET) resin film |
| Tube | Silicon rubber, teflon |
| Electrical Parts | |
| Heater | Stainless steel and others |
| Motor | Iron, Aluminum, Copper wire and others |
| Circuit boards | Composites with board, condenser, resister and transformer |
| Power cord & wiring materials and others | Synthetic rubber, resins |
| Sensor | Stainless steel and others |

8. When a trouble occurs

Safety unit and error indications

The table shows possible causes of activation of the safety unit and solutions.

[Error indication]

When an abnormality occurs to the inlet temperature controller or the outlet temperature controller, the touch panel at the operation panel displays the error screen. When an abnormality occurred, confirm description of the error and implement appropriate solutions.

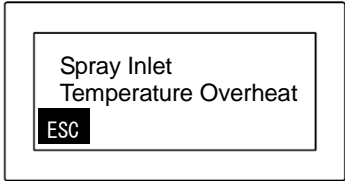
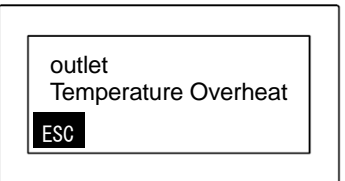
| Display | Possible causes | Solutions |
|---|--|--|
|  | ① Disconnection of the thermocouple sensor ② When the displayed inlet temperature is at 230°C or over ③ Malfunction of the blower | ① Replacement of the thermocouple sensor ② Lower the set temperature or adjust air amount. ③ Replacement of the blower |
|  | ① Disconnection of the thermocouple sensor ② When the displayed outlet temperature is at 110°C or over ③ Malfunction of the blower | |

* When the measured temperature exceeds the set upper limit (upper limit of inlet temperature: 230°C; upper limit of outlet temperature: 110°C), "Over Heat" will appear, the heater output will stop and when that status continues for one minute, the temperature error above will be displayed. The safety unit will perform automatic REV operation for five seconds when a temperature error occurred while the blower is ON, the heater is OFF, or the liquid sending pump was in operation and then shift to the stop mode.

The same process as shown above will take place when the disconnection of the temperature sensor occurred. The temperature controller will indicate "-----".

Pressing "ESC" key will release the error screen and the status will return to the "BLOWER ON" and "HEATER OFF" status.

* You can select English or Chinese with the language select function as the OSD language for error indication.

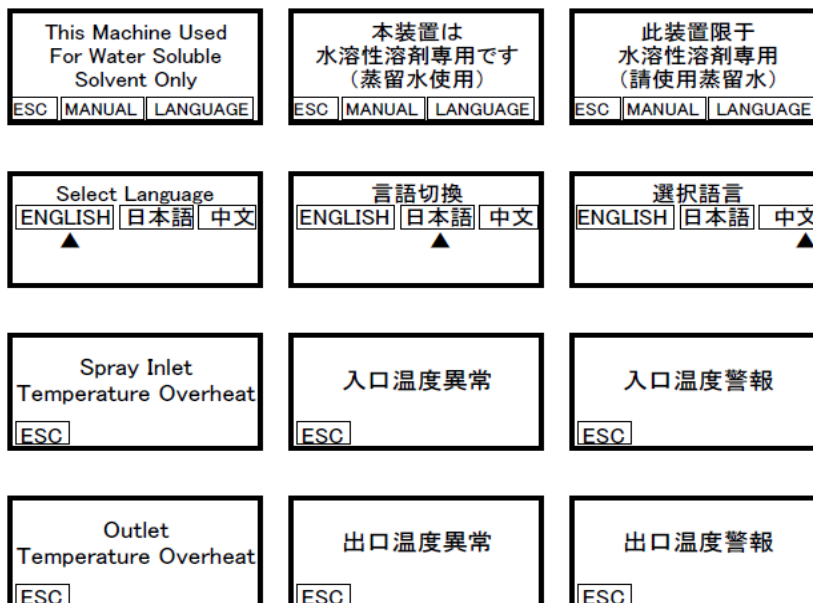

8. When a trouble occurs

Confirmation and language select for the manual

You can select English or Chinese with the language select function as the OSD language for the manual.

[Confirmation and language select for the manual] Pressing ESC key will return to the standby screen.

| | | |
|---|--|--|
| Select Language [ENGLISH] [日本語] [中文] ▲ | 言語切換 [ENGLISH] [日本語] [中文] ▲ | 選択語言 [ENGLISH] [日本語] [中文] ▲ |
| This Machine Used For Water Soluble Solvent Only ESC [MANUAL] [LANGUAGE] | 本装置は 水溶性溶剤専用です (蒸留水使用) ESC [MANUAL] [LANGUAGE] | 此装置限于 水溶性溶剤専用 (請使用蒸留水) ESC [MANUAL] [LANGUAGE] |
| *Select Inlet *Set Inlet Temp *BLOWER ON ESC [BACK] [NEXT] | ◇[INLET]選択 ◇[INLET]温度設定 ◇[BLOWER] ON ESC [BACK] [NEXT] | ◇選択「INLET」 ◇設定「INLET」温度 ◇「BLOWER」ON ESC [BACK] [NEXT] |
| *Set Air Flow Volume *HEATER ON *Wait Temp Stabilize ESC [BACK] [NEXT] | ◇風量設定 ◇[HEATER] ON ◇温度の安定を待つ ESC [BACK] [NEXT] | ◇設定風量 ◇「HEATER」ON ◇等待温度安定 ESC [BACK] [NEXT] |
| *Set Air Pressure →0.1MPa *Outlet Changeable ESC [BACK] [NEXT] | ◇スプレー圧力設定 →0.1MPa ◇[Outlet]切替可 ESC [BACK] [NEXT] | ◇調整噴霧圧力 →0.1MPa ◇可切换到「Outlet」 ESC [BACK] [NEXT] |
| *Set Solution Tube *PUMP FWD ON *Run Test Cycle ESC [BACK] [NEXT] | ◇送液チューブセット ◇[PUMP FWD] ON ◇試運転 ESC [BACK] [NEXT] | ◇安裝送液管 ◇「PUMP FWD」ON ◇調試運行 ESC [BACK] [NEXT] |
| *Set Distilled Water *Spray Test *Fine Adjust ESC [BACK] [NEXT] | ◇蒸留水をセット ◇スプレー試運転 ◇微調整を行う ESC [BACK] [NEXT] | ◇使用蒸留水 ◇噴霧測試 ◇試運行時再調整 ESC [BACK] [NEXT] |
| *After Adjustment *Set Sample *Run Spray ESC [BACK] [NEXT] | ◇微調整終了後 ◇試料液へ切替セット ◇噴霧開始 ESC [BACK] [NEXT] | ◇再調整之後 ◇使用試料溶液 ◇噴霧開始 ESC [BACK] [NEXT] |
| *After Cycle *Set Distilled Water *Set Temp Down ESC [BACK] [NEXT] | ◇試料噴霧終了後 ◇蒸留水へ切替 ◇温度設定を下げる ESC [BACK] [NEXT] | ◇試料噴霧完之後 ◇換成蒸留水噴霧 ◇降低設定温度 ESC [BACK] [NEXT] |
| *After Spray DW *PUMP FWD→OFF *HEATER→OFF ESC [BACK] [NEXT] | ◇蒸留水噴霧終了後 ◇[PUMP FWD]→OFF ◇[HEATER]→OFF ESC [BACK] [NEXT] | ◇蒸留水噴霧完之後 ◇「PUMP FWD」→OFF ◇「HEATER」→OFF ESC [BACK] [NEXT] |
| *Inlet Temp < 60°C *Turn Flow Vol to 0 *BLOWER→OFF ESC [BACK] [NEXT] | ◇入口温度60°C以下 ◇風量を最小に絞る ◇[BLOWER]→OFF ESC [BACK] [NEXT] | ◇入口温度60°C以下 ◇風量閘到最小 ◇「BLOWER」→OFF ESC [BACK] [NEXT] |
| *Shut Off Air *Power OFF *Take Out Powder ESC [BACK] [NEXT] | ◇コントロール弁を閉じる ◇電源スイッチをOFF ◇粉体を取出し ESC [BACK] [NEXT] | ◇停止供給加圧空気 ◇「POWER」→OFF ◇取出粉体 ESC [BACK] [NEXT] |
| Do Maintenance According To Manual ESC [BACK] [NEXT] | 取扱説明書に従い 定期点検及び 清掃を行って下さい ESC [BACK] [NEXT] | 請按照使用說明書 進行定期檢查 並清掃機器 ESC [BACK] [NEXT] |
| Sol Speed ↑ OutTemp ↓ Air Vol ↑ OutTemp ↑ Spl Conc ↑ OutTemp ↑ ESC [BACK] [NEXT] | 送液速度 ↑ 出口温度 ↓ 風量 ↑ 出口温度 ↑ 試料濃度 ↑ 出口温度 ↑ ESC [BACK] [NEXT] | 送液速度 ↑ 出口温度 ↓ 風量 ↑ 出口温度 ↑ 試料濃度 ↑ 出口温度 ↑ ESC [BACK] [NEXT] |

8. In the Event of Failure...

Trouble Shooting

| Symptoms | Possible causes | Countermeasures |
|--------------------------------|--|--|
| The POWER does not turn ON. | <ul style="list-style-type: none"> ● ELB is turned OFF ● Malfunction of the power supply ● The wire ire short-circuited. ● Malfunction of power switch | <ul style="list-style-type: none"> ● Turn the ELB ON ● Check the power supply circuit ● Replace the cord ● Replace the power switch |
| Blower does not activate. | <ul style="list-style-type: none"> ● Incorrect connecting of the connector of blower ● Breaking of blower input cord ● Blower switch failure ● Blower motor failure ● Blower motor brush failure ● Blower circuit failure and wiring failure | <ul style="list-style-type: none"> ● Connect correctly. ● Replace the cart. ● Replace the touch panel, sequencer or thermo regulator. ● Replace the motor or motor substrate ● Replace the brush ● Maintain or replace the part |
| Heater does not activate. | <ul style="list-style-type: none"> ● Incorrect connecting of the connector of heater ● Activated the protection circuit caused by the failure of the other device (displayed error) ● Activated the protection circuit without turning on the blower switch ● Heater disconnection ● Heater switch failure ● Heater circuit failure and wiring failure | <ul style="list-style-type: none"> ● Connect correctly. ● Solve the problem, and turn ON the switch. ● Turn ON the blower, and then turn ON the heater switch. ● Replace the part. ● Replace the touch panel or sequencer ● Maintain the part or replace the thermo regulator. |
| Feeding pump does not activate | <ul style="list-style-type: none"> ● The indicator of the pump adjusting dial is at "0" ● Pump switch failure ● Pump motor failure ● Pump circuit failure and wiring failure ● Imperfect nozzle attachment | <ul style="list-style-type: none"> ● Adjust the dial. ● Replace the touch panel or sequencer ● Replace the motor or driver ● Maintain the part ● Check and adjsutment of attachment status of the nozzle |
| Pulse jet does not activate | <ul style="list-style-type: none"> ● Failure of pressuring air source ● Connecting failure of tube ● Solenoid valve failure ● Pulse jet switch failure ● Pulse jet circuit failure and wiring failure | <ul style="list-style-type: none"> ● Make arrangement aiming for appropriate status. ● Maintain or replace the part. ● Replace the part. ● Replace the touch panel or sequencer ● Maintain the part |

8. In the Event of Failure...

Trouble Shooting

| Problem | Possible Cause | Solution |
|--|--|--|
| Thermo regulator failure | <ul style="list-style-type: none"> ● Defective display function ● Sensor failure ● Activated overheating protection function | <ul style="list-style-type: none"> ● Maintain or replace the part. ● Replace the part. ● Lower the temperature setting |
| Adjusting dial (Not activated blower and pump) | <ul style="list-style-type: none"> ● Adjusting circuit failure and wiring failure ● Lack of capacity of heater due to excessive drying airflow | <ul style="list-style-type: none"> ● Maintain the part or replace the thermo regulator. ● No error. For operating this unit with high temperature, decrease the flow rate of the drying air or increase the setting value. |

- ◆ In the case if the error other than listed above occurred, turn off the power switch and primary power source immediately. Contact the shop of your purchase or nearest Yamato Scientific Service Office.

9. After Service and Warranty

When requesting a repair

When requesting a repair

If any trouble occurs, immediately stop operation, turn the power switch off, pull out the power plug and contact your dealer, our sales office or our customer service center.

Information necessary for requesting a repair

- Model name of the product
 - Serial number
 - Date (y/m/d) of purchase
 - Description of trouble (as in detail as possible)
- } See the warranty card or the nameplate on the unit.
} See the section "3.Names of parts and their function" on page 9.

Be sure to indicate the warranty card to our service representative.

Warranty card (attached separately)

- Warranty card is given by your dealer or one of our sales offices and please fill in your dealer, date of purchase and other information and send it to our customer service center by Facsimile (408-235-7725). Then, store it securely.
- Warranty period is one full year from the date of purchase. Repair service for free is available according to the conditions written on the warranty card.
- For repairs after the warranty period consult your dealer, one of our sales offices or our customer service center.
Paid repair service is available on your request when the product's functionality can be maintained by repair.

Minimum holding period of repair parts

The minimum holding period of repair parts for this product is seven years after end of production. Repair parts here refer to parts necessary for maintaining performance of the product.

10. Specification

Specifications of main unit

| | | |
|----------------------|--|---|
| Configuration | | Splay Dryer+Mini Splay Attachment [GF-300] |
| Function | | Splay drying |
| Sample for drying | | Solution, Suspension, Emulsion (Flammable organic solvent is invalid.) |
| Total weight | | Approx. 91kg |
| ADL311/ADL311S | Thermo regulator | PID digital thermo regulator |
| | Heater | 2kW (AC200V) ~2.88kW (AC240V) |
| | Blower | Bypass type commutator blower |
| | Stirring mechanism | Induction motor |
| | Sample feeding pump | Proportioning Peli pump |
| | Pressure gauge for spray air | Pressure gauge for bourdon tube Measurement range: 0 to 294kPa |
| | Blowout mechanism for pressurizing air | Use pulse jet type solenoid valve |
| | Temperature adjustment range | INLET:0~220°C (differed depending on airflow), OUTLET : 0~60°C |
| | Temperature adjustment accuracy | ±1°C |
| | Temperature display | Digital display of the temperature around Inlet/Outlet (metal-sheathed thermocouple element K) |
| | Adjusting range for drying air | 0~0.7m ³ /min |
| | Power supply *1 | AC220V single phase 17A (AC200V 16A AC240V 18A) |
| | External dimensions *2) (WxDxH) | 580x420x1125 |
| | Weight | Approx. 80kg |
| Attached accessories | <ul style="list-style-type: none"> ▪ Specimen tube Silicon I.D.2 mmxO.D.4 mmx1m 2 ▪ Outlet temperature sensor 1 ▪ Exhaust hose Made of vinyl chloride I.D.:50 mmx2m 1 ▪ Hose band #64 1 ▪ Tetlon braided hose 5m (for connecting pressurized air) 1 ▪ Hose clamp 2 ▪ Earth wire 1 ▪ Current fuse (2A) 1 ▪ Warranty card 1 ▪ Operation manual | |

ADL311S, compared to ADL311, supports connection to the organic solvent recovery unit GAS410.

10. Specification

| | | | | |
|---|-----------------------------|---|---|-------|
| Mini Splay Attachment [GF300] | Model | GF300 | | |
| | Amount of water evaporation | Max. Approx. 1300ml/h | | |
| | Spray nozzle | Binary Nozzle 1A | | |
| | Drying chamber | Made from super hard glass | | |
| | Cyclone | Made from super hard glass | | |
| | Container for product | Made from super hard glass | | |
| | Dust removal of nozzle tip | Pulse jet type (used the pressuring air blower mechanism for GB210 model) | | |
| | Weight | Approx. 11 kg | | |
| | Parts list | Cyclone | | 1set |
| | | Drying chamber | | 1set |
| | | Product collecting container | | 1 |
| | | Container holding band | | 1 |
| | | Packing 40A, 50A | | 1each |
| | | Power clamp 40A, 50A | | 1each |
| | | Cap | | 1 |
| | | Connecting ferrule (D) | | 1 |
| | | PFA wave shaped tube 1-1/2, 3 feet long (for connecting the cyclone) | | 1 |
| | | Hose clip | | 2 |
| | | Distributor (O-rings P16, P135 included) | | 1 |
| Hex bolt M6 x 20 | | | 3 | |
| Flat washer M6 | | | 3 | |
| Spring washer M6 | | | 3 | |
| Aluminum honeycomb | | | 1 | |
| Pipe | | | 1 | |
| Spray nozzle | | | 1 | |
| Round single-ended wrench | | | 1 | |
| Polyethylene tank for 100g of 5% sodium chloride solution | | 1 | | |
| Warranty card | | 1 | | |

*1 Including capacity of service receptacle (2A).

*2 The outer dimension does not include the projection part.

Please remind that this product may be changed the specification and others for revision without any announce to the user.

11. Wiring Diagram

ADL311 Wiring Diagram

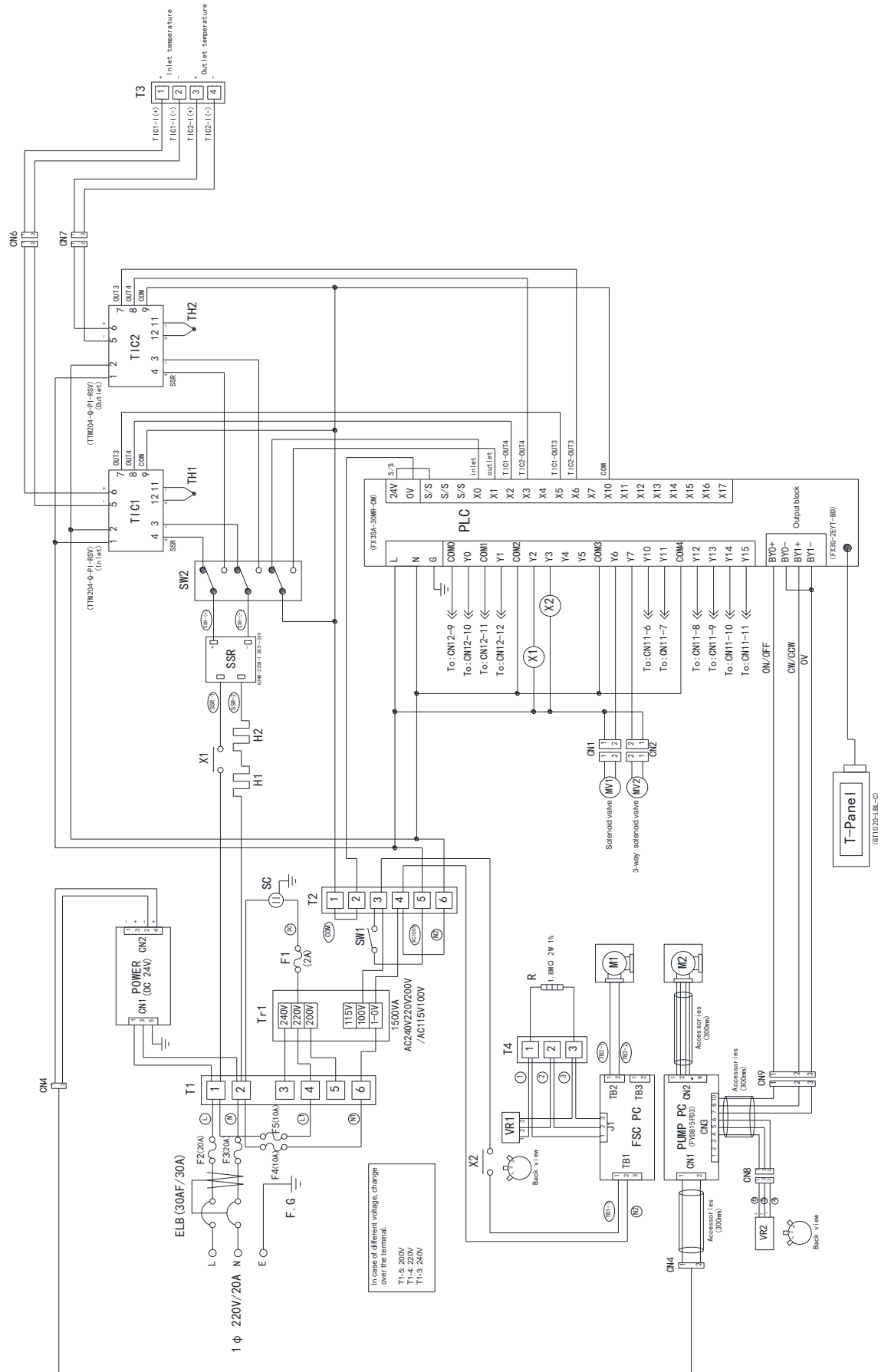

11. Wiring Diagram

ADL311 Wiring Diagram

| Symbol | Part name | Symbol | Part name |
|-----------|---|---------|--|
| ELB | Electric Leakage Breaker | F1 | Current fuse (2A) |
| Tr1 | Stepdown transformer | F2~3 | Current fuse (20A) |
| T1~T4 | Terminal block | F4~5 | Current fuse (10A) |
| T-Panel | Touch panel | VR1 | Blower volume |
| PLC | Sequencer | VR2 | Liquid sending pump volume |
| TH1 · TH2 | Temperature sensor | MV1 | PULSE JET solenoid valve |
| TIC1 | Inlet temperature controller | M1 | Blower motor |
| TIC2 | Outlet temperature indicator | M2 | Liquid sending pump motor |
| FCS PC | Blower speed control substrate | X1 | Power relay |
| PUMP PC | Liquid sending pump speed control substrate | X2 | FAN relay |
| SSR | Solid-state relay | SW1 | Power switch |
| H1 · H2 | Heater | SW2 | Inlet/outlet temperature control selector switch |
| Power | Switching power | CN1~CN9 | Relay connector |
| SC | Service outlet | R | Resistance |

11. Wiring Diagram

ADL311S Wiring Diagram

| Symbol | Part name | Symbol | Part name |
|-----------|---|-------------|--|
| ELB | Electric Leakage Breaker | F2~3 | Current fuse (20A) |
| Tr1 | Stepdown transformer | F4~5 | Current fuse (10A) |
| T1 to T4 | Terminal block | VR1 | Blower volume |
| T-Panel | Touch panel | VR2 | Liquid sending pump volume |
| PLC | Sequencer | MV1 | PULSE JET solenoid valve |
| TH1 & TH2 | Temperature sensor | MV2 | Solenoid valve for switching GAS pipes |
| TIC1 | Inlet temperature controller | M1 | Blower motor |
| TIC2 | Outlet temperature indicator | M2 | Liquid sending pump motor |
| FCS PC | Blower speed control substrate | X1 | Power relay |
| PUMP PC | Liquid sending pump speed control substrate | X2 | FAN relay |
| SSR | Solid-state relay | SW1 | Power switch |
| H1 & H2 | Heater | SW2 | Inlet/outlet temperature control selector switch |
| Power | Switching power | SW3 | Nozzle detection reset switch |
| SC | Service outlet | CN1 to CN10 | Relay connector |
| F1 | Current fuse (2A) | CN11 & CN12 | Panel connector |
| R | Resistance | | |

12. System Chart

System Chart

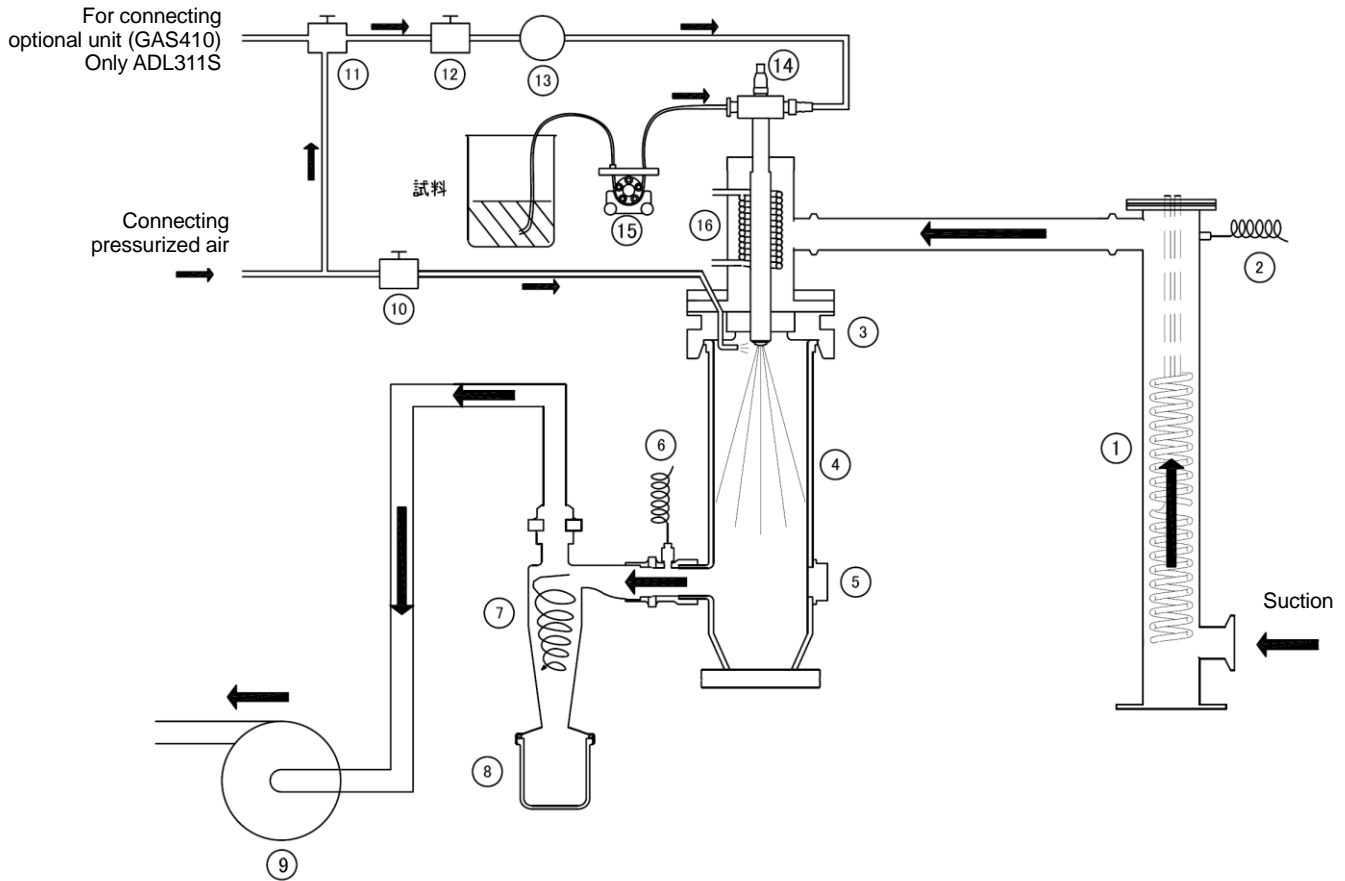

| Number | Part name | Number | Part name |
|--------|------------------------------|--------|-------------------------------------|
| ① | Heater | ⑨ | Blower |
| ② | Inlet temperature sensor | ⑩ | Solenoid valve |
| ③ | Distributor | ⑪ | 3-way solenoid valve (ADL311S only) |
| ④ | Drying chamber | ⑫ | Needle valve |
| ⑤ | Cap | ⑬ | Pressure meter |
| ⑥ | Outlet temperature sensor | ⑭ | Spray nozzle |
| ⑦ | Cyclone | ⑮ | Liquid sending pump |
| ⑧ | Product collecting container | ⑯ | Nozzle cooling connecting port |

13. Principle of Operation

Principle of Operation

Refer to "System Chart" on P. 39.

The sample is fed from the appropriate container to ⑭ spray nozzle with ⑮ feeding pump. Moreover, the compressed air pressure from the compressor is regulated by ⑫ needle valve, and sent to ⑭ spray nozzle. At the tip of the nozzle, the compressed air mixed with the sample, and the mixed sample is sprayed inside ④ drying chamber. This sample becomes drop shape that the particle diameter is approx. 20 μ and the surface area is 3,000 cm² per 1 liter of sample. On the other side, air is suctioned into the unit by ⑨ blower, and heated up till the temperature set on ① heater. Since the contact area of the heated air and the sample is very large, the approx. 90% or more of the moisture will be evaporated in the dry chamber momentarily.

The sample that became fine powder by drying is fed to ⑦ cyclone under further drying, and separated from the evaporated part here, and then, fed to ⑧ container for product. Time after the sample is sprayed with the nozzle till it is fed into this container does not take 0.5 seconds. Moreover, since the sample powder is always surrounded with the solvent vapor (moisture vapor), the temperature does not rise extremely around the particle due to the vaporization heat. Therefore, in case of the heat-sensitive material such as an enzyme, disintegration can be executed without dropping degree of activity even under the condition as a temperature around outlet= 80 Celsius degree.

The evaporated moisture is evacuated to outside via the blower.

The temperature conditions under examination are displayed on the display panel by the inlet temperature sensor and the outlet temperature sensor. Moreover, the airflow that dries the sample is measured by the wind velocity sensor in the wind-flow tube, and is displayed on the display panel.

In case that the sample adhesion to the nozzle tip is outstanding, open ⑩ solenoid valve to let the pressurizing air blow to the nozzle tip from ③ distributor in order to remove the adhesives. If necessary, remove ⑤ cap to take the outside air into the inside of the chamber.

14. Replacement parts table

Common parts for ADL311/ADL311S

| | Part name | Standards | Manufacturer | Code No. |
|---|---------------------|--|--------------|------------|
| ※ | Packing (C) | AD311S-40440 | YSC | B081999025 |
| ※ | Packing (D) | AD311S-40430 | YSC | B081999026 |
| ※ | Packing (E) | AD311S-40550 | YSC | B081999017 |
| ※ | Filter | AD311S-40540 | YSC | B040300005 |
| ※ | Heat resistant hose | GS type 38×42×L 650 | YSC | B080807016 |
| ※ | Filter | AD311S-40400 | YSC | B040300004 |
| ※ | Sheathed heater | ADL311SC_01_03_02 | YSJ | H090101023 |
| | Bellows | 40KF L=160 Connected to the upper cylindrical pipe | YSJ | A041500019 |
| | Blower motor | TPSBW800A AC100V | YSC | B080103001 |
| ※ | Teflon tube | No.9003 φ6×φ8 | YSJ | A080807007 |
| | Clamp | 40KF | YSJ | A041500010 |
| ※ | Center ring | 40KF | YSJ | A041500010 |
| ※ | O-ring | P23 4-types D Viton For upper cylindrical pipe | YSC | F0020058 |
| ※ | O-ring | P145 4-types D Viton For upper cylindrical pipe | YSC | B081902003 |
| | Pressure meter | DU-1/4-60-6 | YSC | B042300005 |
| | Needle valve | 2412T-S-1/8- | YSC | B040405001 |
| | Toggle switch | 2M-2032 | YSC | B011501005 |
| | Switch | HLS112A-G | YSC | A0020715 |
| | Volume | RV24YN20S B103 077C | YSC | B010204002 |
| | Volume | RV24YN20S B204 069C | YSC | LT00027711 |
| | Motor | FY8PF15N-D3 For sending liquid | YSC | B011603002 |
| | Driver | FYD815SD3 For sending liquid | YSC | B011401014 |
| | Gear head | 8H30FBN-100 For sending liquid | YSC | B080400001 |
| | Bearing | SSR-1030ZZ For sending liquid | YSJ | A080200006 |

14. Replacement parts table

| Part name | Standards | Manufacturer | Code No. |
|----------------------------|---------------------------|--------------|------------|
| Solenoid valve | AB41-02-5-F-AC100V CKD | YSJ | A040403004 |
| ※ Teflon flexible tube | φ 6.35× φ 4.35×200 | YSC | B080807003 |
| Temperature sensor(Outlet) | ADL311SC_03_01-02 | YSJ | H090101017 |
| Temperature sensor(Inlet) | ADL311SC_03_01-01 | YSJ | H090101018 |
| PLC connecting cable | GT10-C10-R4-8P | YSJ | A020300004 |
| Touch panel | GT2103-PMBLSDC5 | YSJ | B020400001 |
| PLC IN16/OUT14 | FX3SA-30MR-CM | YSJ | A020300033 |
| Output block | FX3G-2EYT-BD | YSJ | B020399001 |
| Temperature controller | TTM204-Q-PI-RSV | YSC | B020101002 |
| Electric Leakage Breaker | KD-LS2123 30A 30mA | YSJ | A010414001 |
| SSR | G3NB-225B-1 DC5~24V | YSJ | A011006011 |
| Relay | HF116F-2/110AL1HSTFW | YSJ | A011002001 |
| Stepdown transformer | ADL311SC_03_02 | YSJ | H090101036 |
| Switching power | HF50W-SF-24 | YSJ | A010801005 |
| Fan control substrate | YY0609-A/FSPC | YSC | B011401013 |
| Liquid tube | GAS41-40610 Silicone | YSJ | LT00027796 |
| Fuse | 250V 2A | YSJ | A010301005 |

Parts for ADL311S

| Part name | Standards | Manufacturer | Code No. |
|---------------------|------------------------------|--------------|------------|
| Micro switch | SS-01GL2 Nozzle port | YSC | B011505003 |
| Solenoid valve | VX3334Q-02-1G1-B 3-way valve | YSC | B040403001 |
| Interface connector | RNJC-RM-20-12-A-1 | YSJ | B011304006 |
| Interface connector | RNJC-RF-20-12-A-1 | YSJ | B011304005 |

Note: Parts marked with * are consumable parts.

14. Replacement parts table

Replacement parts for GF300

| Part name | Standards | Manufacturer | Code No. |
|------------------------------|--|--------------|------------|
| Drying chamber system | GF300-30000 Ultra hard glass | YSC | LT00028136 |
| Cyclone set | GF300-30060 Ultra hard glass | YSC | LT00028785 |
| Container holding band | GF300-40000 Stainless steel | YSC | LT00027540 |
| Nozzle set | GF300-30100 | YSC | LT00028786 |
| ※ O-ring | P16 4 types D Viton | YSC | 4210026021 |
| ※ Aluminum honeycomb | GF300-40120 | YSC | LT00027548 |
| ※ O-ring | P135 4 types D Viton | YSC | F0020073 |
| ※ Cap | GF300-40100 Silicone | YSC | LT00027544 |
| Connecting ferrule (D) | GF300-40080 | YSC | LT00027543 |
| ※ PFA wave formed tube | 1-1/2, 3 feet (915mm) long | YSC | LT00027545 |
| Hose clip | JCS-Win-2A ϕ 35~50 | YSC | LT00027550 |
| ※ Packing | 40A Silicone | YSC | F0220141 |
| ※ Packing | 50A Silicone | YSC | F0220143 |
| Power clamp | 40A | YSC | R0100009 |
| Power clamp | 50A | YSC | R0100012 |
| Product collecting container | GF300-30090 | YSC | LT00027539 |
| Clean out needle | GF300-40190 | | |
| Additional machining drawing | 14293-6-1/16-SS Secondary machining | YSC | LT00027552 |
| ※ Packing | CP-4042-2-TEF | YSC | 3280016002 |
| ※ Gasket (A) | CP104369-TEF | YSC | 3280016003 |
| ※ Gasket (B) | CP3612-TEF | YSC | 3280016006 |
| ※ O-ring | JASO-1017 Haika | YSC | 4210076002 |

Note: Parts marked with * are consumable parts.

15. List of Dangerous Substances



Never use explosive substances, flammable substances and substances that include explosive or flammable ingredients in this unit. Otherwise explosion or fire may result

ADL311S supports organic solvents by connecting it to the optional GAS410. Carefully read the operation manual of GAS410 and take special care for handling of organic solvents.

| | | |
|----------------------|----------------------|--|
| Explosive substance | Explosive substance | ①Nitroglycol, glycerine trinitrate, cellulose nitrate and other explosive nitrate esters |
| | | ②Trinitrobenzen, trinitrotoluene, picric acid and other explosive nitro compounds |
| | | ③Acetyl hydroperoxide, methyl ethyl ketone peroxide, benzoyl peroxide and other organic peroxides |
| Flammable substances | Explosive substances | Metal "lithium", metal "potassium", metal "natrium", yellow phosphorus, phosphorus sulfide, red phosphorus, celluloids, calcium carbide (a.k.a, carbide), lime phosphide, magnesium powder, aluminum powder, metal powder other than magnesium and aluminum powder, sodium dithionous acid (a.k.a., hydrosulphite) |
| | Oxidizing substances | ①Potassium chlorate, sodium chlorate, ammonium chlorate, and other chlorates |
| | | ②Potassium perchlorate, sodium perchlorate, ammonium perchlorate, and other perchlorates |
| | | ③Potassium peroxide, sodium peroxide, barium peroxide, and other inorganic peroxides |
| | | ④Potassium nitrate, sodium nitrate, ammonium nitrate, and other nitrates |
| | | ⑤Sodium chlorite and other chlorites |
| | | ⑥Calcium hypochlorite and other hypochlorites |
| | Flammable substances | ①Ethyl ether, gasoline, acetaldehyde, propylene chloride, carbon disulfide, and other substances with ignition point at a degree 30 or more degrees below zero. |
| | | ②n-hexane, ethylene oxide, acetone, benzene, methyl ethyl ketone and other substances with ignition point between 30 degrees below zero and less than zero. |
| | | ③Methanol, ethanol, xylene, pentyl acetate, (a.k.a.amyl acetate) and other substances with ignition point between zero and less than 30 degrees. |
| | | ④Kerosene, light oil, terebinth oil, isopenthyl alcohol(a.k.a. isoamyl alcohol), acetic acid and other substances with ignition point between 30 degrees and less than 65 degrees. |
| | Combustible gas | Hydrogen, acetylene, ethylene, methane, ethane, propane, butane and other gases combustible at 15°C at one air pressure. |

(Quoted from the separate table 1 in Article 6, the enforcement order of the Industrial Safety and Health Law)

16. Standard installation manual

*Follow the items below to make installation. (Check the procedures separately for optional parts or products of special specifications.)

| Model | Serial number | Date | Installation manager (company name) | Installation manager | Judgment |
|-------|---------------|------|--|----------------------|----------|
| | | | | | |

| No | Item | Implementation method | Table of contents No. Section for reference in manual | Judgment |
|---------------------------|--------------------------------|---|---|----------|
| Specification | | | | |
| 1 | Accessories | Check of quantity according to the accessory columns | 10.Specifications | |
| 2 | Installation | <ul style="list-style-type: none"> Visual check of the environmental status Caution: Surrounding environment | 2. Before using this unit <ul style="list-style-type: none"> At the installation site... | |
| Operation related matters | | | | |
| 1 | Source voltage | <ul style="list-style-type: none"> Measure customer side voltage (ELB etc.) with a tester Measure voltage while the heater is operating (Shall meet the standards) Caution: Use a power supply that meets the standard when you are going to install it on a plug or an ELB. | 2. Before using this unit <ul style="list-style-type: none"> Be sure to connect the earth wire... Use the dedicated outlet for power supply 4. Operating procedures Preparations (1) & (2) 10. Specifications <ul style="list-style-type: none"> Power supply | |
| 2 | Installation of the attachment | Preparations <ul style="list-style-type: none"> Connecting the exhaust duct Connection to the compressor Connection of the spray nozzle cooling mechanism (as necessary) Checking the contents of the GF300 set Installation of the distributor Installation of the nozzle guide Installation of the drying chamber Installation of the temperature sensor Installation of the cyclone, the product collecting container, the cap, and the hose <ul style="list-style-type: none"> Insert the spray nozzle from the ceiling of the main unit and then connect the liquid sending tube and the pressurized air tube | 4. Operating procedures, preparations <ul style="list-style-type: none"> (3) Connection of the exhaust duct (4)Rear of the upper frame... (5)Cooling the spray nozzle (6)Mini spray... (7)On the top of the main unit... (8)...In the center of the distributor... (9)Stage positioning... (10)...The temperature sensor... (11)...The cyclone... Operating method <ul style="list-style-type: none"> Set referring to the left drawing in section(7) | |

16. Standard installation manual

| No | Item | Implementation method | Table of contents No. Section for reference in manual | Judgment |
|-------------|--|--|--|----------|
| 3 | Operation start (Commissioning) | <p>Perform commissioning</p> <ul style="list-style-type: none"> • ELB and the power switch ON • Set the setting select to INLET and set the INLET temperature to 150°C • Installation of the mini spray attachment • Set the BLOWER switch ON and to air amount 0.45m³/min Adjusting volume: 3.3 (50Hz) /5 (60Hz) • Turn the heater switch ON • Setting the liquid sending tube and distilled water • Spraying pure water Set the spray pressure to 0.1MPa when the outlet temperature has risen to around 80°C. Adjust liquid sending speed so that the outlet temperature will be slightly lower than about 75°C • Change from distilled water to the sample and shift to the powder collecting operation | <p>4. Operating procedures Operating method</p> <ul style="list-style-type: none"> • (1)·(2) • (3) on the operation panel... • (4)Mini spray... • (5)Blower switch... • (6) the heater switch... • (7) the liquid sending tube... • (8)·(9) • (10) When the outlet temperature has become stable... | |
| 4 | Operation stop | <p>Stop operation</p> <ul style="list-style-type: none"> • Change from the sample to distilled water and wash inside the spray nozzle Approx.5 min→PUMP switch OFF→ Choke spray pressure to 0 • Turn the HEATER switch OFF • Turn the BLOWER switch OFF when the outlet temperature dropped to 45°C or less • Turn the POWER switch OFF • Collect powder • Clean the containers according to the maintenance method | <p>4. Operating procedures Operating procedures</p> <ul style="list-style-type: none"> • (11)When specimen has been... • (12)Turn the heater OFF... • (12)Turn the heater OFF... • (13)...The power switches... • (14)...The container holding band... • (15)...to the maintenance method <p>6. Maintenance procedures</p> | |
| Description | | | | |
| 1 | Description of operation | Description of operation of each part to the customer according to the manual | 1. Safety precautions to 13. List of hazardous materials | |
| 2 | Error codes | Description of the error codes and countermeasures to the customer according to the manual | 8. When a trouble occurs to 9. After-sales service and warranty | |
| 3 | Maintenance inspection & | Description of operation of each part to the customer according to the manual | 6. Maintenance procedures • Daily inspection/care | |
| 4 | Completion of installation Matters to note | <ul style="list-style-type: none"> • Indicate the installation date and the manager name on the nameplate of the main unit. • Fill in the warranty card with necessary matters and hand it over directly to the customer. • Description of after-sales service route | 9. After-sales service and warranty | |

Responsibility

Please follow the instructions in this document when using this unit. Yamato Scientific has no responsibility for the accidents or breakdown of device if it is used with a failure to comply. Never conduct what this document forbids. Unexpected accidents or breakdown may result in.

Note

- ◆ The contents of this document may be changed in future without notice.
- ◆ Any books with missing pages or disorderly binding may be replaced.

Instruction Manual

Spray Dryer

ADL311/311S

Version Jun. 25, 2015

Revision Oct. 21, 2019

Yamato Scientific America, Inc.
925 Walsh Ave, Santa Clara, CA 95050
Tel:408-235-7725
For technical information
and service, call: 1-800-292-6286
<http://www.yamato-usa.com>