



Flask Mixer

model **LM100/110/200/210**

Instruction Manual

Second Edition

- Thank you for choosing LM100/110/200/210 Flask Mixer from Yamato Scientific Co., Ltd.
- For proper equipment operation, please read and become thoroughly familiar with this instruction manual before use. Always keep equipment documentation safe and close at hand for convenient future reference.

Warning: Read instruction manual warnings and cautions carefully and completely before proceeding.

**Yamato Scientific America Inc.
Santa Clara, CA**

Printed on recycled paper

CONTENTS

1. SAFETY PRECAUTIONS	1
Explanation of Symbols	1
Symbol Glossary	2
Residual Risk Map	3
List of Residual Risks	4
Warnings & Cautions	6
2. PRE-OPERATION PROCEDURES	7
Installation Precautions & Preparations	7
3. COMPONENT NAMES AND FUNCTIONS	10
Packing Details	10
Names and Appearance of Each Part	11
4. INSTALLATION PROCEDURES	12
Installation Method	12
5. USEFUL FUNCTIONS	16
List of Optional Accessories	16
Reference for Stirring Shaft Selection	17
When Using a Stirring Shaft on the Market	17
6. OPERATION PROCEDURES	18
Operation	18
7. MAINTENANCE PROCEDURES	19
Cleaning and Maintenance	19
8. EXTENDED STRAGE AND DISPOSAL	22
Disposal Considerations	22
9. TROUBLESHOOTING	23
Troubleshooting Guide	23
10. SERVICE & REPAIR	24
Request for Repair	24
11. SPECIFICATIONS	25
12. WIRING DIAGRAM	26
LM100 Wiring Diagram	26
LM200 Wiring Diagram	26
Wiring Diagram Symbol Glossary	26
13. REPLACEMENT PARTS LIST	27
Consumables/Replacement Parts	27
Sketch Drawing	27
14. LIST OF HAZARDOUS SUBSTANCES	28
15. STANDARD SETUP MANUAL	29

1. SAFETY PRECAUTIONS

Explanation of Symbols

A Word Regarding Symbols

Various symbols are provided throughout this text and on equipment to ensure safe operation. Failure to comprehend the operational hazards and risks associated with these symbols may lead to adverse results as explained below. Become thoroughly familiar with all symbols and their meanings by carefully reading the following text regarding symbols before proceeding

 **Warning** Signifies a situation which may result in serious injury or death (Note 1.)

 **Caution** Signifies a situation which may result in minor injury (Note 2) and/or property damage (Note 3.)

(Note 1) Serious injury is defined as bodily wounds, electrocution, bone breaks/fractures or poisoning, which may cause debilitation requiring extended hospitalization and/or outpatient treatment.

(Note 2) Minor injury is defined as bodily wounds or electrocution, which will not require extended hospitalization or outpatient treatment.

(Note 3) Property damage is defined as damage to facilities, equipment, buildings or other property.

Symbol Meanings



Signifies warning or caution.
Specific explanation will follow symbol.



Signifies restriction.
Specific restrictions will follow symbol.



Signifies an action or actions which operator must undertake.
Specific instructions will follow symbol.

1. SAFETY PRECAUTIONS

Symbol Glossary

Warning



General Warning

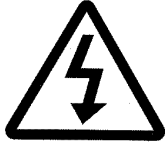

Danger!: High Voltage



Danger!: Extremely Hot



Danger!: Moving Parts



Danger!: Blast Hazard

Caution



General Caution



Caution: Shock Hazard!



Caution: Burn Hazard!



Caution: Do Not Heat Without Water!



Caution: May Leak Water!



Caution: Water Only



Caution: Toxic Chemicals

Restriction



General Restriction



No Open Flame



Do Not Disassemble



Do Not Touch

Action



General Action Required



Connect Ground Wire



Level Installation



Disconnect Power



Inspect Regularly

1. SAFETY PRECAUTIONS

Residual Risk Map

These figures indicate positions of caution labels.

The numbers shown in the figure represent the numbers of residual risk relevant to the location concerned, which are provided in the List of Residual Risks for this unit. For details of individual residual risks, see the List of Residual Risks.

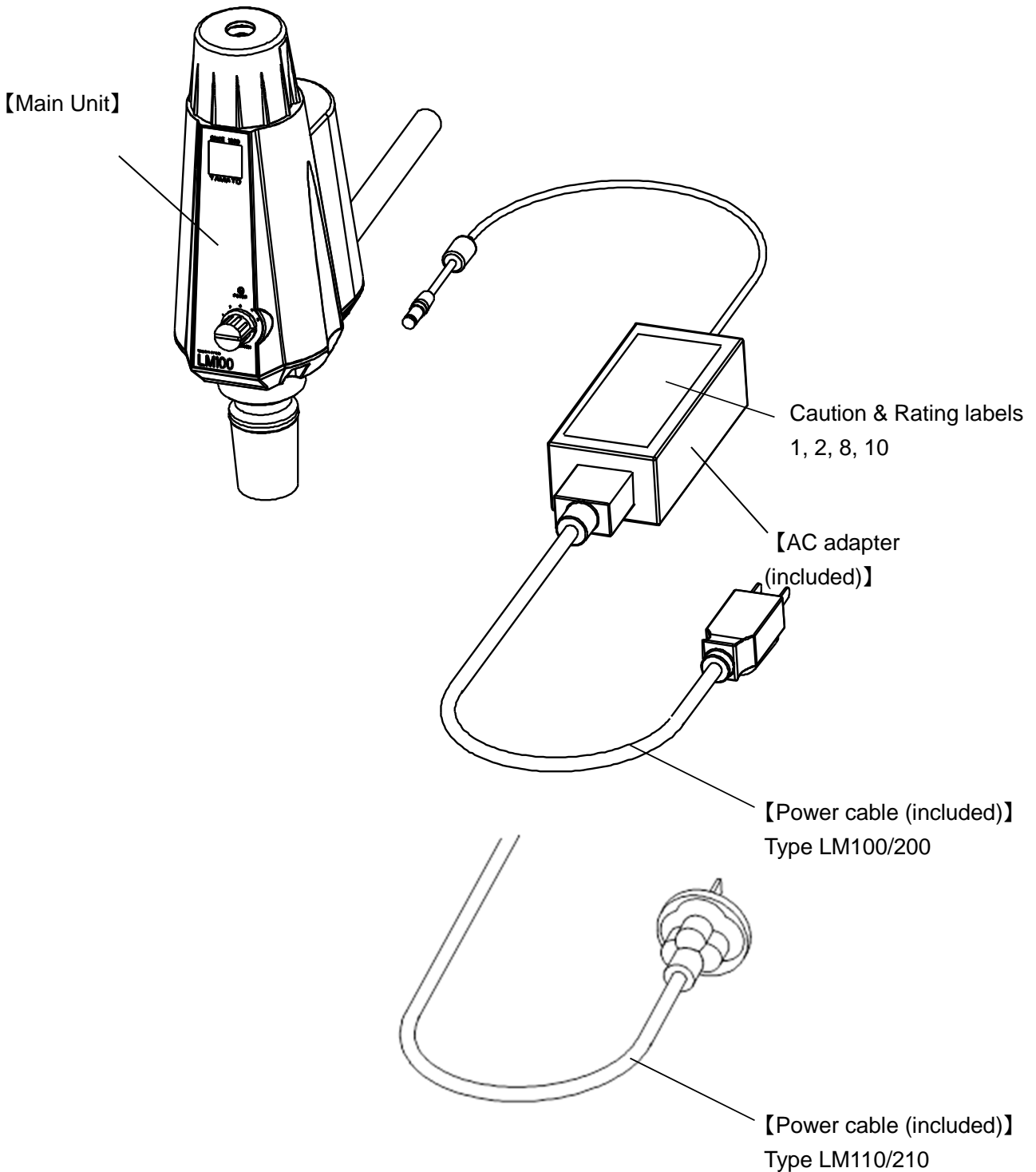

*Contact us if the caution signs are no more visible because nameplate is peeled off or texts are eliminated. We will send you a new nameplate. (for charge)

1. SAFETY PRECAUTIONS

List of Residual Risks

List of residual risks (instructions for risk avoidance)

This list summarizes residual risks to avoid personal injuries and property damages during or related to the use of equipment.

Be sure to fully understand or receive instructions on how to use, maintain and inspect equipment before starting operation.

[During installation]				
No.	Degree of risks	Risk description	Protective measures taken by the user	Relevant sections
1	Warning	Fire/Explosion	Install in a location free of flammables and explosives.	Chapter 1
2	Warning	Fire/Electric shock	DO NOT operate equipment when abnormalities are detected.	Chapter 1
3	Warning	Fire	DO NOT operate equipment with power cable bundled or tangled	Chapter 1
4	Caution	Fire/Electric shock	DO NOT damage power cable.	Chapter 1
5	Warning	Fire/Electric shock	NEVER disassemble or modify equipment.	Chapter 1
6	Warning	Fire/ Electric shock/ Water leakage	Choose an appropriate installation site	2.1
7	Warning	Fire/Electric shock	Install in a dry location.	2.2
8	Warning	Injury	Use after attaching the coupling cover.	2.3
9	Warning	Fire/Electric shock	Connect to a properly rated power supply.	2.4
10	Warning	Fire/Electric shock	Always use a dedicated AC adapter.	2.5
11	Caution	Injury	About attaching and detaching sample containers.	2.6
12	Caution	Fire/Electric shock	Handle power cable with care.	2.9

1. SAFETY PRECAUTIONS

List of Residual Risks

[In use]				
No.	Degree of risks	Risk description	Protective measures taken by the user	Relevant sections
13	Caution	Injury	About operation	2.7
14	Caution	Injury	Installation of coupling cover	4.4
15	Caution	Fire	Connection of power cable	4.5
16	Warning	Injury	Check the glassware before operation.	Chapter 1
17	Caution	Fire/Electric shock	DO NOT operate equipment during thunderstorms.	Chapter 1
18	Caution	Stirring failure	When a power failure occurs.	Chapter 1

[Daily inspection/maintenance]				
No.	Degree of risks	Risk description	Protective measures taken by the user	Relevant sections
19	Caution	Fire/Electric shock	Precautions for maintenance	Chapter 7

[Extended storage/disposal]				
No.	Degree of risks	Risk description	Protective measures taken by the user	Relevant sections
20	Warning	Fire	Extended storage.	Chapter 8

1. SAFETY PRECAUTIONS

Warnings & Cautions



Install in a location free of flammables and explosives.

This unit is not explosion proof structure. There is a danger of fire if it is used in an atmosphere with flammable or explosive properties. Also, if flammable solution is heated and stirred, the solution will evaporate and the motor part of unit can become an ignition source, which may result in explosion. When these solutions are used in a sealed sample container, reflux solvent vapor using a cooling pipe, exhaust the vapor outside by providing the container with an air outlet, or operate in a fume hood or other laboratory equipment. See "14. LIST OF HAZARDOUS SUBSTANCES" (P.28).



DO NOT operate equipment when abnormalities are detected.

If smoke or unusual odors begin emitting from unit, or if any other abnormalities are detected, terminate operation immediately, turn unit off and disconnect power cable. Continued operation under such conditions may result in fire or electric shock.



DO NOT operate equipment with power cable bundled or tangled

Operating unit with the power cable bundled or otherwise tangled, may cause power cable to overheat and/or catch fire.



DO NOT damage power cable

Do not damage power cable by bend, forcibly bending, pulling or twisting. Doing so may cause fire and/or electric shock.



NEVER disassemble or modify equipment.

Attempting to dismantle or modify unit may cause malfunction, fire or electric shock.



Check the glassware before operation.

Damaged or scratched glass parts attached to this unit may cause unexpected accidents. Make sure that the glass parts are not damaged or scratched, and handle them carefully.



DO NOT operate equipment during thunderstorms.

In the event of a thunderstorm, turn off unit by the speed control dial on the front of this unit and disconnect power cable from outlet. A direct lightning strike may cause damage to the control circuit, fire or electric shock.



When a power failure occurs.

In case of power failure, turn off unit by the speed control dial on the front of this unit for safety.

2. PRE-OPERATION PROCEDURES

Installation Precautions & Preparations

Warning

1. Choose an appropriate installation site.



DO NOT install unit:

- where flammable or corrosive liquids/gases may be present.
- where external temperature will exceed 35°C or will fall below 5°C.
- where the humidity is outside the range of 65±20% RH
- in direct sunlight or outdoors.
- where there is constant vibration.
- where power supply is erratic.
- where installation surface is not completely level, not even or not stable.
- in excessively dusty locations.



Install unit in a location with sufficient space, as specified below:

top	60cm or more
back	15cm or more
right side	20cm or more
left side	20cm or more
front	10cm or more

Unit should be installed perpendicular to the installation floor. Operating with this unit being inclined may cause unexpected accidents.

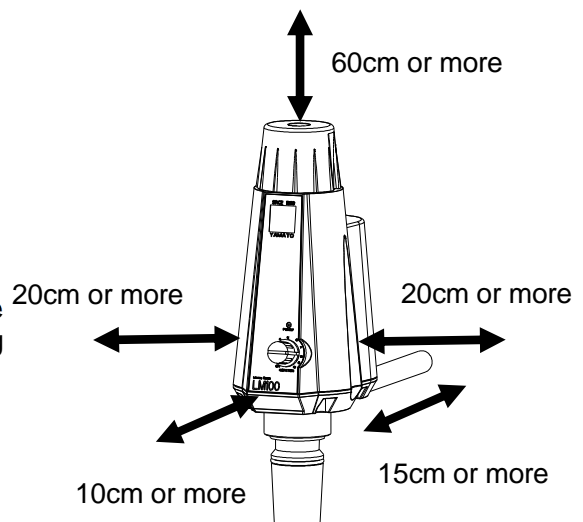

2. Install in a dry location.



Unit is not waterproof. Install unit where it will be free from liquid spray and other moisture. Failure to do so may result in this instrument mechanisms becoming wet, cause malfunction, electric shock and/or fire.

3. Use after attaching the coupling cover.



The coupling rotates at high speed, hair and clothing may get caught in.

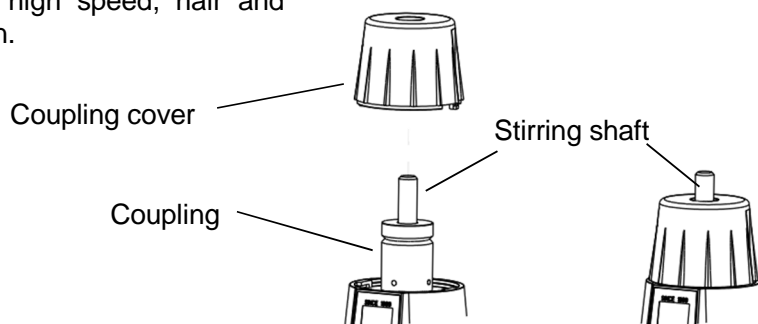

2. PRE-OPERATION PROCEDURES

Installation Precautions & Preparations

4. Connect to a properly rated power supply.



Use a dedicated power supply that matches electric capacity.

Electric capacity: LM100/200 AC100-120V single phase 50/60Hz 1A

Electric capacity: LM110/220 AC200-240V single phase 50/60Hz 1A

AC adapter shape specification	
C14	

Standard test conditions with no load should be as follows. Operational voltage range: $\pm 10\%$, Voltage range at which specified performance is guaranteed: $\pm 5\%$, Frequency rating: $\pm 1\%$.

*Check the line voltage on outlet to be used and properly evaluate whether to utilize a line being shared by other equipment. If unit is not activated by turning the speed control dial clockwise, take an appropriate course of action, such as connecting unit to a dedicated power source

Power cable-terminal processing

Voltage	Power cable specification	Power supply side terminal processing
115V	3 core 0.75mm ² *1	With type A plug (3P)
220V	3 core 1.0mm ² *1	With type O plug (3P)

* The length of the power cable is about three meters outside unit including the AC adapter.

*1 Nominal cross-sectional area of conductor

5. Always use a dedicated AC adapter.



Do not use an AC adapter used in home appliances or any other equipment. Since there are various types of AC adapters based on voltage, capacity etc., Be sure to use the supplied AC adapter for this unit.

6. About attaching and detaching sample containers.



- Take care when handling glassware. Since glass parts are easy to break, please handle with care so as not to be injured.
- Wear safety glasses and gloves whenever operate this unit in order to avoid injury in case that glassware breaks.
- Fix the sample container with a clamp. There is a danger that the stirrer and the container may fall unable to withstand the weight.

7. About operation



- When unit becomes overloaded, safety device of motor (overload protection function) activates and stops stirring. Be careful when stirring samples with high viscosity or large amount, or when operating at high-speed rotation.
- Do not move or transport unit during operation. Since you may injure yourself by touching the rotating part, move and transport it after stopping unit.
- Do not place chemicals around unit while operating. It may lead to unexpected accidents.

8. Pressure inside the sample container



- The stirring seal of this unit cannot be used with positive pressure inside the sample container. Using it under positive pressure may result in malfunction of this unit.
- When stirring a sample that becomes positive pressure during sealed condition, reflow the solvent vapor using a cooling pipe, discharge it by providing the container with an air outlet, or operate in a fume hood or other laboratory equipment

2. PRE-OPERATION PROCEDURES

Installation Precautions & Preparations

9. Handle power cable with care.





- Use power cable included with unit. Using other than the supplied power cable may cause power cable to overheat resulting in fire.
- Do not operate equipment with power cable bundled or tangled. Operating unit with the power cable bundled or otherwise tangled, may cause power cable to overheat and/or catch fire.
- Inserting multiple cables into a single outlet, using branch outlets or extension cords, may cause power cable to overheat and/or catch fire.
- Check the plug pins before connecting to outlet. If dust settles on the plug pins, it may become moistened and cause short-circuit possibly resulting in fire.
- Route power cable properly so as not to get in the way while operating unit. If the cable is near the rotating part of unit, the cable may become entangled during operation.
- Do not modify, bend, forcibly twist or pull on power cable. Doing so may cause fire and/or electric shock.
- Remove the dust of the outlet frequently. If you use unit with the plug inserted in the outlet for a long time, dust may accumulate in the gap between the outlet and the power plug, which may lead to equipment failure and/or fire. (Tracking phenomenon)
- Do not run power cable in a place subject to be stepped on by people. It may cause falls or a fire.
- Do not risk damage to power cable by positioning it under desks or chairs, or by allowing it to be pinched between objects. Doing so may cause fire and/or electric shock
- Do not place power cable near kerosene/electric heaters or other heat-generating devices. Doing so may cause power cable insulation to overheat, be damaged and/or catch fire, which may result in electric shock.
- Turn the speed control dial to OFF immediately and disconnect from facility outlet, if power cable becomes partially severed or damaged in any way. Contact original dealer of purchase for information about replacing power cable if it becomes damaged. Continued operation under such conditions may result in fire or electric shock

3. COMPONENT NAMES AND FUNCTIONS

Packing Details

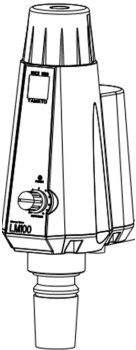
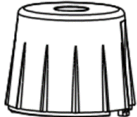
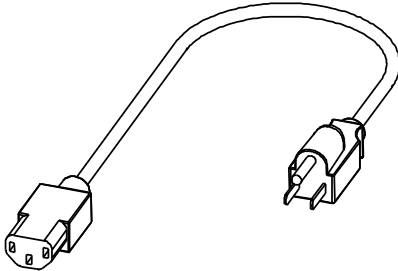
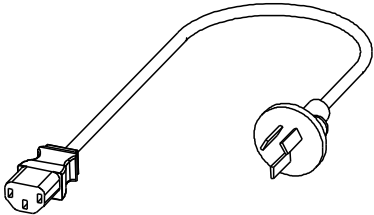
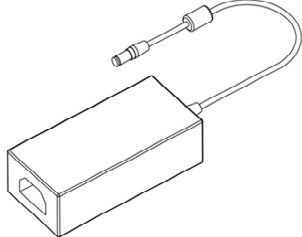
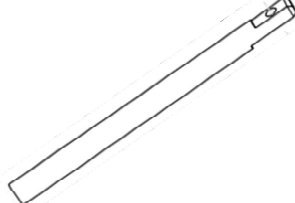
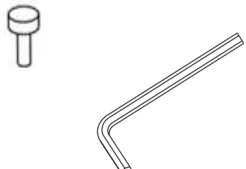
Please make sure that you have all the following parts before use. If there is something insufficient, contact original dealer of purchase.

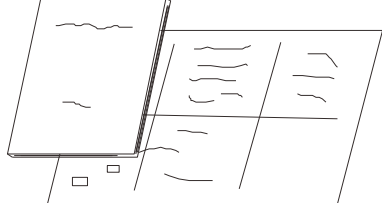
<p>① Main body</p>  <p>LM100</p>	<p>② Coupling cover (Built in the main body)</p> 	<p>③ Power cable</p>  <p>LM100/200</p>
<p>④ Power cable</p>  <p>LM110/210</p>	<p>⑤ AC adapter</p> 	<p>⑥ Arbor</p> 
<p>⑦ Hexagon socket head cap screw (M5) ⑧ Hex wrench</p> 	<p>⑨ Flask clip (¥ 24/40)</p> 	<p>⑩ Instruction manual ⑪ Warranty card</p> 

3. COMPONENT NAMES AND FUNCTIONS

Names and Appearance of Each Part

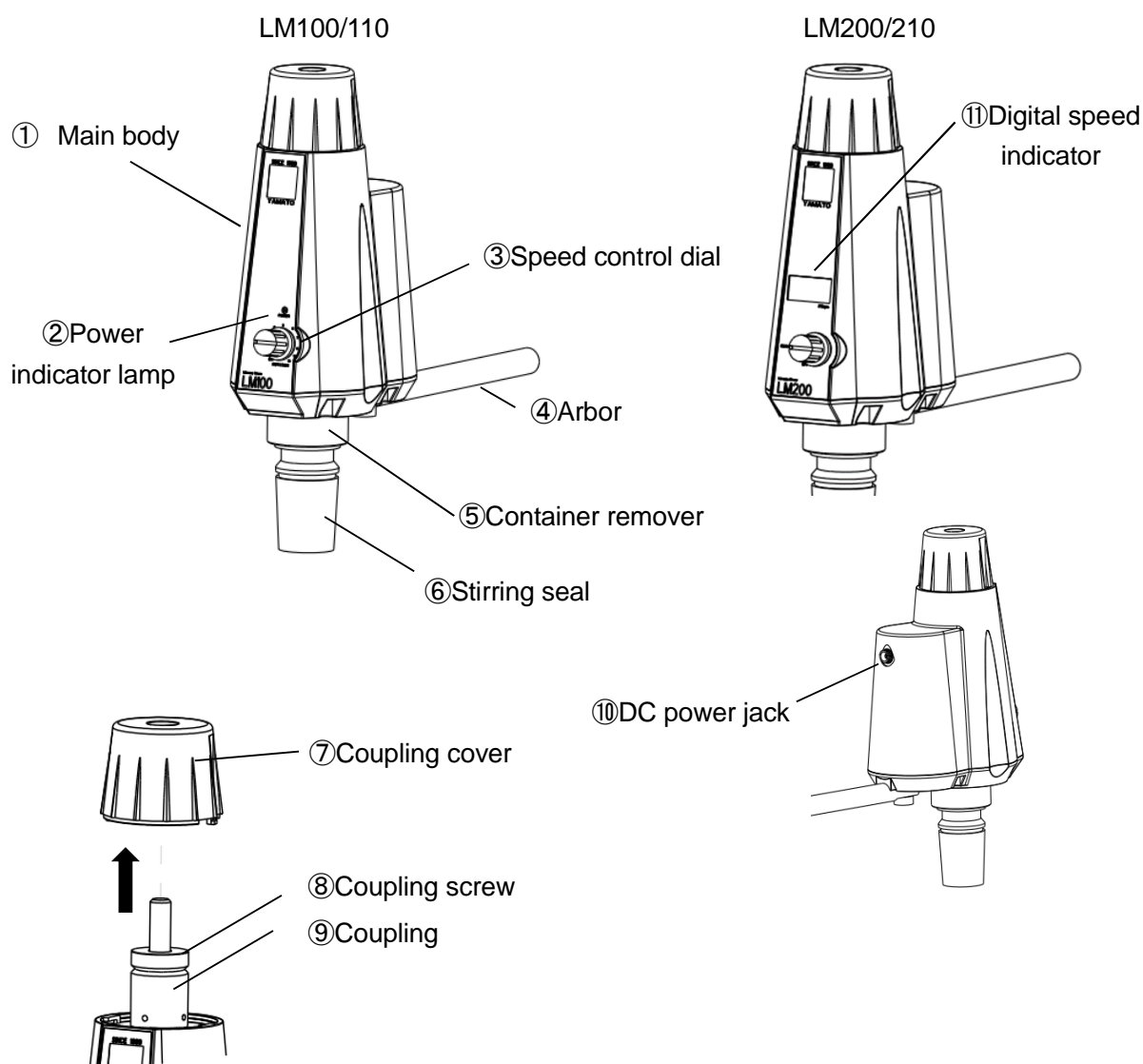

No.	Name	Description
①	Main body	Stores motor and its driving circuit
②	Power indicator lamp	Operation indicator lamp
③	Speed control dial	Turns ON/OFF power supply and adjusts the rotation speed of stirring shaft
④	Arbor	Fixed to a stand or a laboratory support using a muff
⑤	Container remover	Used to remove sample container adhered to stirring seal
⑥	Stirring seal	Mounted on ground joint of sample container
⑦	Coupling cover	Prevents hair and clothing from getting caught in driving part
⑧	Coupling screw	Used to attach/detach the stirring shafts
⑨	Coupling	Used to attach/detach the stirring shafts
⑩	DC power jack	AC adapter cord connection
⑪	Digital speed indicator	Operation indicator lamp and rotation speed indication

4. INSTALLATION PROCEDURES

Installation Method

1. Arbor installation

- Tighten the hexagon socket head cap screws attached to the base bottom of this unit with a hex wrench and fix the arbor securely. If the tightening of the arbor is loose, unit may vibrate or fall.
- Pay attention to the load capacity of arbor. Estimated load capacity of arbor is as follows.
 - In a 1000 mL sample flask, approximately 500 mL of water
- Fix the arbor to an optional stand or a laboratory support (sold separately) by using a muff (option) or other clamps.
 - * When fixing this unit to a stand or other laboratory support, ensure stabilized stand placement and that there is no looseness of the fixed part before installing. It may cause unexpected accidents.

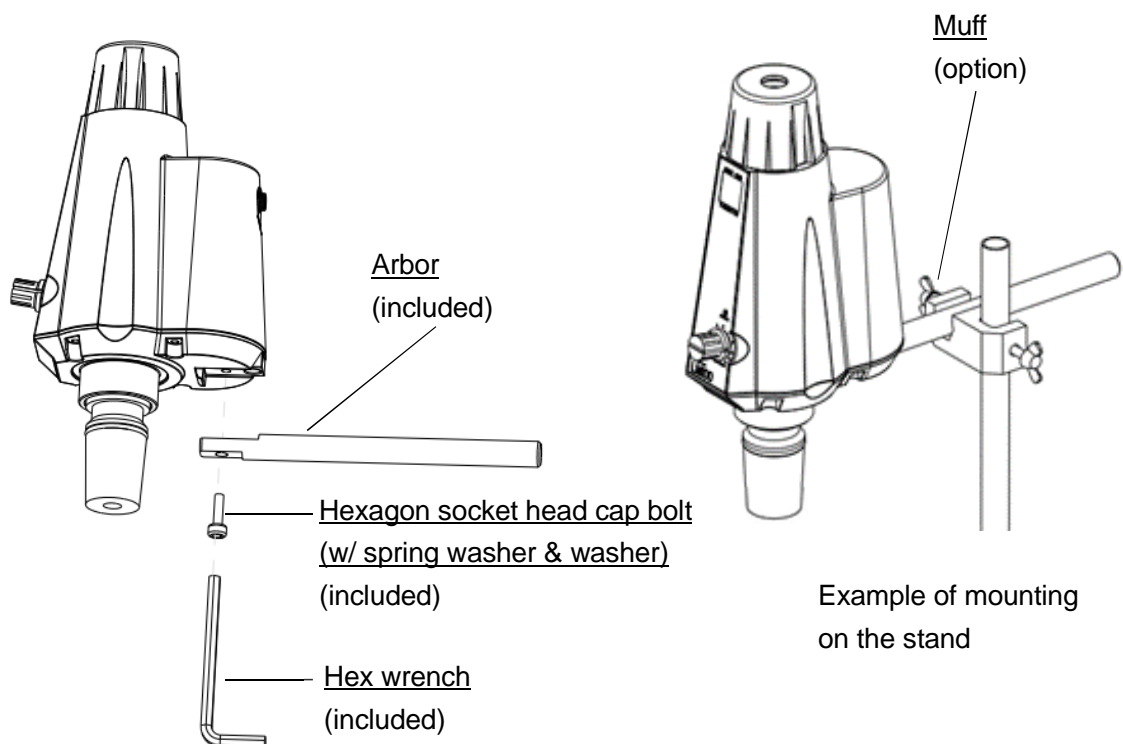

Arbor load capacity.

- **!** Estimated loading capacity of Arbor is about 500mL of water in a 1000mL sample flask.
 - * When using a three-necked flask with a capacity exceeding 1000mL or installing a cooling pipe in the side tube of the three-necked flask, take measures such as installing a double-opening clamp on the neck of the flask.
- When stirring at 350 rpm or more, vibration is likely to occur, so please take measures such as attaching a double-opening clamp to the neck of the flask.

4. INSTALLATION PROCEDURES

Installation Method

2. Installation and removal of stirring shaft

●Installation of stirring shaft

- (1) Insert a stirring shaft from the bottom of the stirring seal and let the coupling penetrate.
- (2) Hold the coupling with one hand, turn the coupling screw clockwise (right), tighten firmly, and fix the stirring shaft.

●Removal of stirring shaft, adjustment of length

When adjusting the length of the stirring shaft or removing the shaft, hold the coupling with one hand, turn the coupling screw in the counterclockwise direction (left) to loosen it, and slide the stirring shaft.

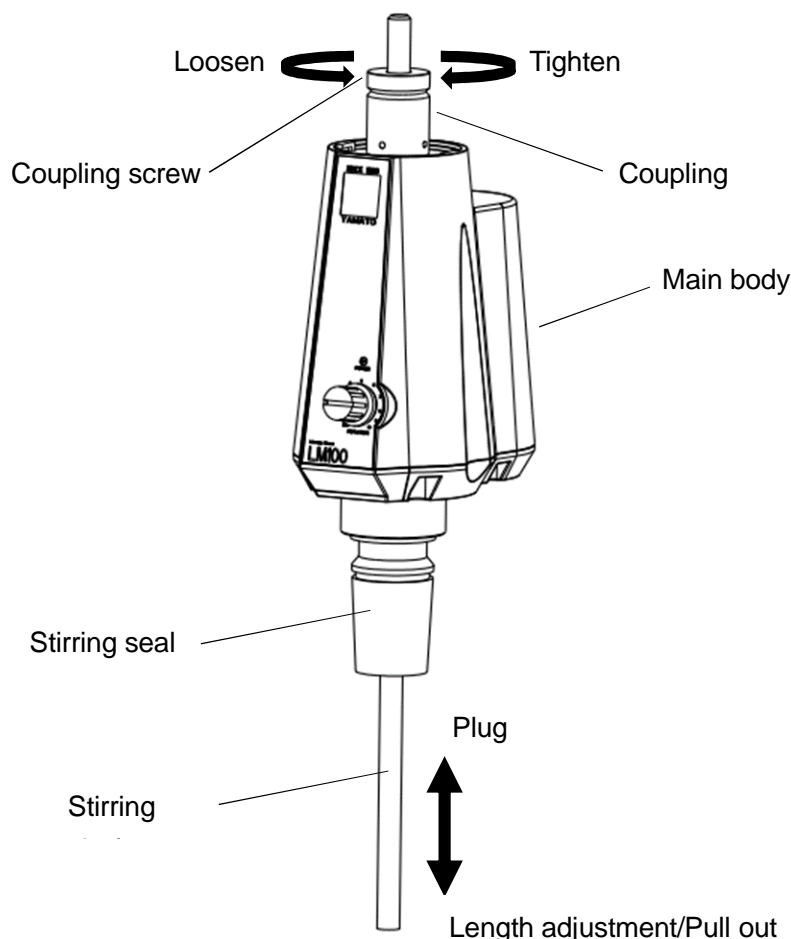

Precautions on installation and removal of stirring shaft.



- The outer diameter of the stirring shaft which can be used is $\phi 8\text{mm}$. Also, some stirring shafts on the market (especially glass shafts) cannot be installed even with outer diameter of 8mm, so we recommend using optional accessories.
- Do not use a bent stirring shaft. Using the stirring shaft in a bent state may cause the main body to vibrate, the sample container to be damaged, or the main body to fall.
- Clean the stirring shaft well with a dry cloth before installing it. If dirt, oil, etc. are applied to the stirring shaft, it may run idle or drop off, damaging the sample container, or injury may occur.
- Tighten the coupling screw securely. If it is insufficient fixation, the stirring shaft may run idle or fall, causing damage to the sample container or personal injury. Do not tighten the coupling screw without stirring shaft. The internal parts are deformed and the stirring shaft cannot be attached.

4. INSTALLATION PROCEDURES

Installation Method

3. Installation and removal of containers

- Glass containers of $\text{¥} 24/40$ standard can be attached. (It is also possible to recombine into a stirring seal of $\text{¥} 29/42$ standard by option.)

(1) Turn the container remover counterclockwise (left) and move it to the main unit side. (If container remover is down to the container side, it cannot be fixed securely.)

(2) Fit the stirring seal and the ground joint of the sample container.

* Firmly insert stirring seal until it reaches taper end of the joint.

(3) Fix the stirring seal and the sample container with a flask clip.

(4) When removing the sample container, remove the clip and turn the container remover clockwise (right). The sample container will slip off the stirring seal.
* Remove the sample container while holding it firmly. The sample container may fall.

- Method of recombining into stirring seal of option $\text{¥} 29/42$ standard

(1) Remove the three screws with the included hex wrench (M5) on the side of the stirring seal and remove the stirring seal from the main body of the drive unit.

(2) Attach the optional stirring seal set onto the drive unit and fix it with the three screws on the side.

$\text{¥} 29/42$ stirring seal set includes snap ring, O-ring and all other parts in the figure in step (5) of "3. Replacing stirring seal parts" (P. 21).

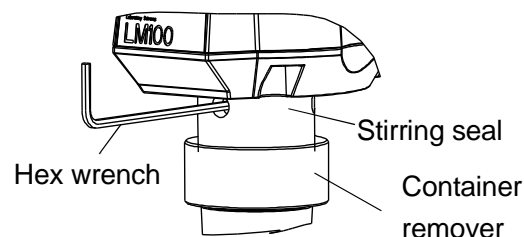
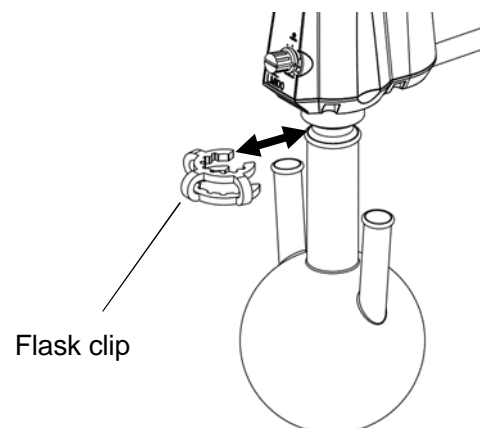
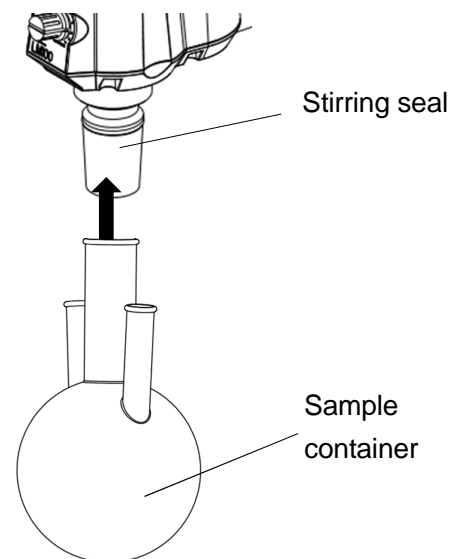
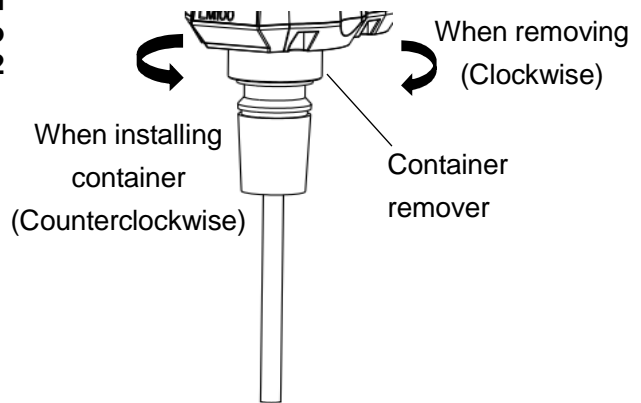

4. INSTALLATION PROCEDURES

Installation Method

4. Installation of coupling cover



- Be sure to install the coupling cover before using. Hair and clothing may get caught in the coupling.

Insert the rib of the coupling cover into the groove of the main body and rotate the coupling cover clockwise to fix it.

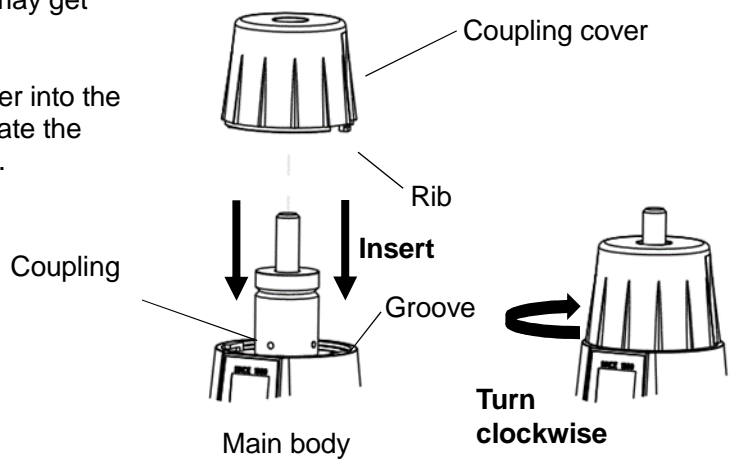

5. Connection of power cable



- Use power cable and AC adapter included in the product. If you use something other than the one included, it may catch fire.
- (1) Insert power cable into AC adapter.
 - (2) Check that the speed control dial on the front side is OFF before inserting the cord of AC adapter into the DC power jack on the back of unit.
 - (3) Plug power cable into a wall outlet.

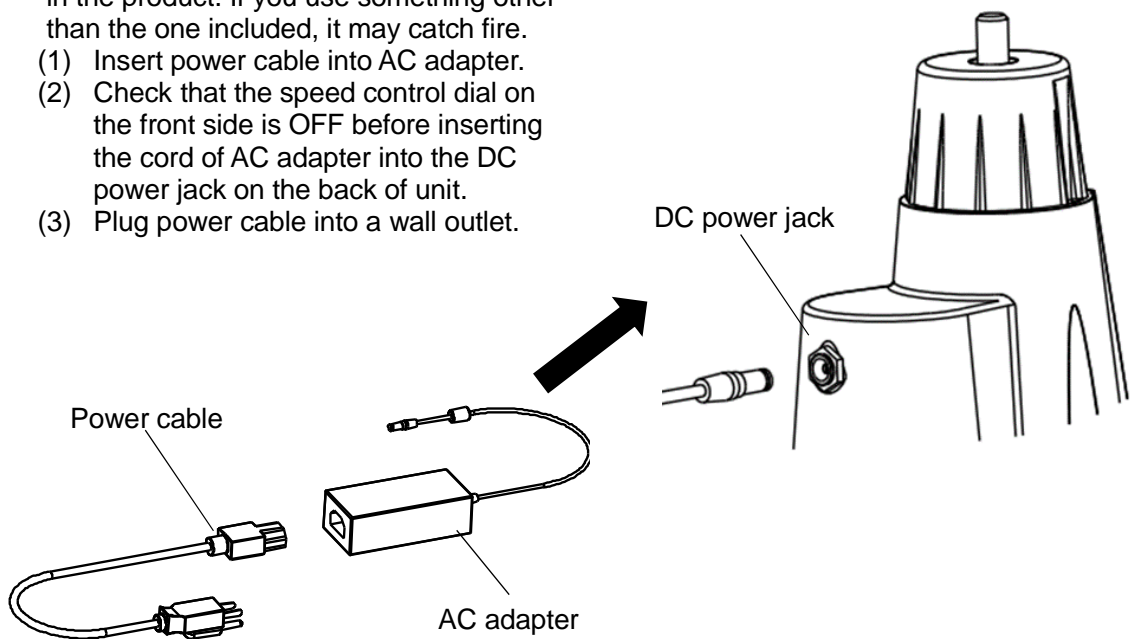



Overload protection function



- Overload protection function may activate and stop the motor when stirring samples with high viscosity or large amount, or when operating at high-speed rotation. Always operate this unit with margin in relation to stirring capability of unit.
 - When the overload protection function is activated, the operation of the motor stops. For LM100/110, operation lamp will illuminate, and for LM200/210 "0 rpm" will show in the digital speed indicator. Turn the speed control dial to OFF and then back to ON to restore the motor operation.
- * Remove the cause(s) of the overload before restart unit.

5. USEFUL FUNCTIONS

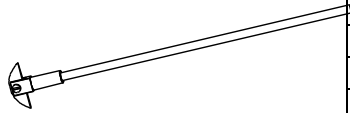
List of Optional Accessories

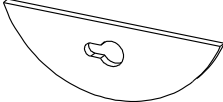
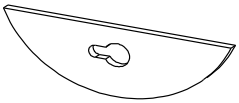
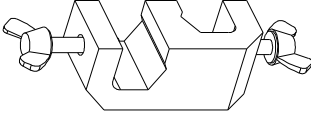
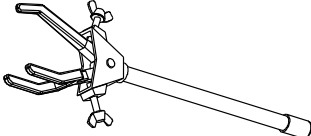
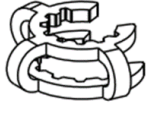
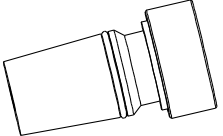
Product name (model)	Product code	Remarks
PTFE stirring shaft (with blade) 	(OLM10)	231615 PTFE with blade L350mm × φ30mm
	(OLM12)	231616 PTFE with blade L450mm × φ30mm
	(OLM14)	231617 PTFE with blade L450mm × φ50mm
	(OLM16)	231618 PTFE with blade L450mm × φ80mm
	(OLM18)	231619 PTFE with blade L600mm × φ80mm
	(OLM20)	231620 PTFE with blade L600mm × φ100mm
	(OLM22)	231621 PTFE with blade L600mm × φ120mm
Glass stirring shaft 	(OLM24)	231622 L=350mm
	(OLM26)	231623 L=400mm
	(OLM28)	231624 L=530mm
PTFE half-moon blade 	(OLM30)	231625 φ40mm × 16mm×t3
	(OLM32)	231626 φ50mm × 17mm×t3
	(OLM34)	231627 φ60mm × 17mm×t4
	(OLM36)	231628 φ100mm × 17mm×t4
	(OLM38)	231629 φ125mm × 30mm×t5
Glass half-moon blade 	(OLM40)	231630 φ50 × 17 × t3.3mm
	(OLM42)	231631 φ80 × 17 × t3.8mm
Muff 	(OLM44)	231632 φ5 to φ13mm
	(OLM46)	231633 φ6 to φ17mm
	(OLM48)	231634 φ9.5 to φ29mm
Double open clamp 	(OLM50)	231635 Tightening adjustment range 3 to 55mm, shaft diameter 10mm Conforming flask: 50mL to 3000mL
	(OLM52)	231636 Tightening adjustment range 5 to 80mm, shaft diameter 12mm Conforming flask: 50mL to 5000mL
Flask clip 	(OLM54)	231637 For ₩ 29/42, 2 pieces
	(OLM56)	231638 For ₩ 24/40, 2 pieces
Stirring seal set 	(OLM58)	231639 ₩ 24/40 standard ground joint ₩ 29/42 standard ground joint
	(OLM68)	231644 • OLM58/68 sets details Stirring seal [₩ 24/40(OLM58), ₩ 29/42(OLM68)] Oil seal housing, FKM oil seal, bearing spacer, bearing, spacer, snap ring, container remover, FKM O-ring

5. USEFUL FUNCTIONS

List of Optional Accessories

Product name (model)		Product code	Remarks
FKM oil seal	(OLM60)	231640	FKM-70 (Standard replacement part), 2 pieces
PTFE oil seal	(OLM62)	231641	PTFE (Chemical resistant), 2 pieces
FFKM O-ring	(OLM64)	231642	For $\text{J}29/42$ OLM68 Chemical resistant O-ring for stirring seal for side mounting
	(OLM66)	231643	For $\text{J}24/40$ Chemical resistant O-ring for stirring seal for side mounting
Y type stand	---	231086	H725 x ϕ 25 Foot dimensions: W400 (Inside dimension 310) x D420mm

Reference for Stirring Shaft Selection

●PTFE stirring shaft (with blade)/Glass stirring shaft (See P.18 for applicable rotation speed)

JIS standard Three-necked flask capacity (mL)	OLM10	OLM12	OLM14	OLM16	OLM18	OLM20	OLM22	OLM24	OLM26	OLM28
50	x	x	x	x	x	x	x	o	Δ	Δ
100	o	o	Δ	x	x	x	x	o	Δ	Δ
200	o	o	o	x	x	x	x	o	o	Δ
300	o	o	o	o	Δ	x	x	o	o	Δ
500	x	o	o	o	Δ	Δ	x	x	o	Δ
1000	x	Δ	o	o	o	o	Δ	x	x	o
3000	x	x	x	x	o	o	o	x	x	o
5000	x	x	x	x	o	o	o	x	x	o

●Glass stirring shaft + half-moon blade (See P.18 for applicable rotation speed)

JIS standard Three-necked flask capacity (mL)	OLM30	OLM32	OLM34	OLM36	OLM38 (For separable flask)	OLM40	OLM42
50	o	x	x	x	x	x	x
100	o	o	x	x	x	o	x
200	o	o	x	x	x	o	x
300	o	o	x	x	x	o	x
500	Δ	o	o	x	x	o	o
1000	Δ	Δ	o	o	x	o	o
3000	Δ	Δ	o	o	x	o	o
5000	Δ	Δ	o	o	x	o	o

o: Recommended Δ : Although it can be installed, there is a risk of stirring failure and vibration
x: Cannot be installed

When Using a Stirring Shaft on the Market

- Use a stirring shaft of nominal diameter ϕ 8 (ϕ 7.90 to ϕ 7.95mm).
- When using a large stirring blade on the market, please pay attention to vibration. Do not use it when it is vibrating abnormally.

6. OPERATION PROCEDURES

Operation

1. Operation



● Before starting operation, be sure to check that the coupling cover is attached and that the speed control dial is OFF.

- (1) Turning the speed control dial clockwise turns on the power.
- (2) Turning the dial further increases rotation speed.

Adjust rotation speed by observing the digital speed indicator for LM200, and by referring to the table below for LM100/110.

LM100/110 rotation characteristic table (reference value)

Dial value	Approximate rotation speed (rpm)
ON-	50-
1	170
2	410
3	680
4	940
4.5	1000

* It is an estimate of the number of revolutions in no-load operation. Individual difference of product is 1000 rpm \pm 5% at dial value 4.5. Individual differences will increase as you lower the dial value.

- (3) When you finish operating, turn the speed control dial counterclockwise until it clicks and stop the rotation.

* Confirm power ON/OFF

LM100/110: power indicator lamp ON/OFF

LM200/210: digital speed indicator ON/OFF

LM100/110

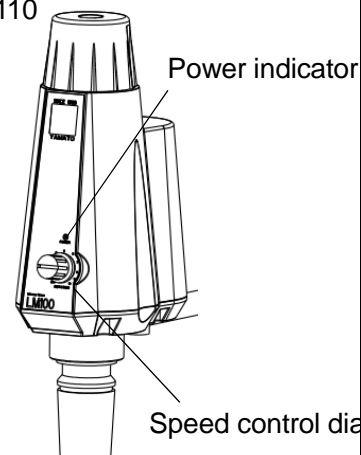

LM200/210

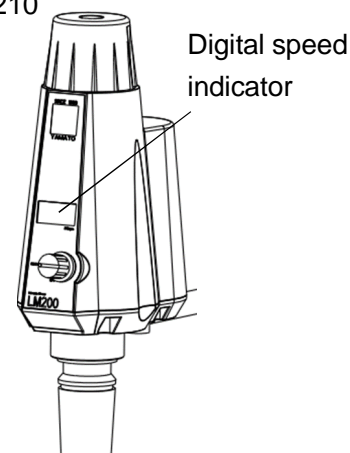

2. Rotation speed range



● When operating unit, observe the following rotation speed range. Using this unit at rotation speed out of range may lead to equipment malfunction and/or breakage of stirring shaft.

- 50 to 1000 rpm: FKM oil seal with PTFE stirring shaft
PTFE oil seal with glass or SUS stirring shaft
- 50 to 300 rpm: FKM oil seal with glass or SUS stirring shaft
PTFE oil seal with PTFE stirring shaft

3. After operation



If unit will be out of service for an extended period, turn the speed control dial counterclockwise to OFF and disconnect power cable from the outlet. Connecting power cable with the dial ON may result in unexpected accident.

7. MAINTENANCE PROCEDURES

Cleaning and Maintenance

Precautions for maintenance



- Do not attempt to disassemble unit. Contacting live parts may cause electric shock or personal injury.
Remove the dust of the outlet frequently. If you operate unit with the plug inserted in the outlet for a long time, dust may accumulate in the gap between the outlet and the power plug, which may lead to equipment failure and/or fire. (Tracking phenomenon)
- Conduct maintenance and cleaning of unit with proper procedures and supplies. Never pour water directly on unit, or use paint thinner, scouring powder, petroleum, kerosene, acid, or other abrasives and solvents to clean unit. Superficial damage and/or discoloration, as well as electric shock may result.
- Do not leave unit in a corrosive atmosphere. If you leave unit in a place with high concentration of acid or organic solvent, the color of the exterior may be faded or peeled off. It also causes corrosion of the board and AC adapter, which may result in equipment malfunction.

1. Maintenance method

- (1) Before cleaning, be sure to turn the speed control dial counterclockwise to turn it off, stop rotating, and then unplug the power plug from the outlet.
- (2) Clean unit with a soft, damp cloth. Use neutral detergent for dirt that is difficult to remove, wipe off with a cloth after using detergent.

2. Change of coupling rubber

When the holding force of the stirring shaft drops, if the stirring shaft does not pass through the coupling, replace the coupling rubber.

- (1) Turn the coupling screw counterclockwise (left) to remove it.
- (2) Remove the contact ring and the coupling rubber inside the coupling.
- (3) Insert a new coupling rubber and contact ring inside the coupling.
* Put the coupling rubber first and then put the contact ring.
- (4) Turn the coupling screw clockwise (right).
* Tighten the coupling screw securely so that the stirring shaft does not slip.

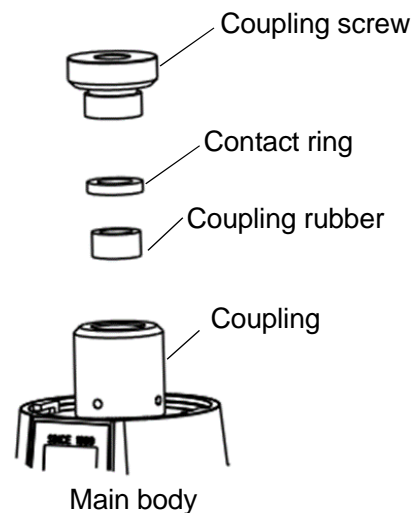

7. MAINTENANCE PROCEDURES

Cleaning and Maintenance

3. Replacing stirring seal parts

■ When the degree of vacuum is lowered

Procedure for changing the oil seal inside the stirring seal

(1) Turn the container remover clockwise to loosen it, remove three hexagon socket head cap bolts with hex wrench (included with OLM64/66), and remove the stirring seal.

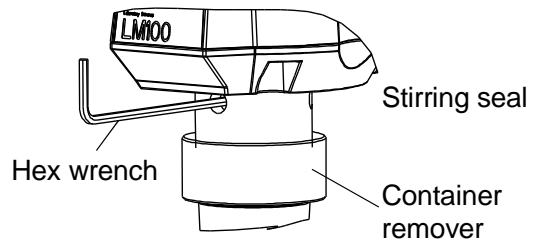

(2) Remove snap ring from the stirring seal with hex wrench hooking on the ring.

* Be careful not to damage Teflon.

* Be careful not to lose the snap ring.

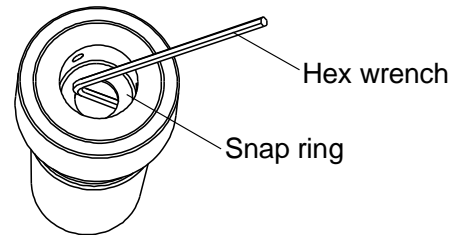

(3) As shown in the Figure, place the tip of hex wrench into the gap between the stirring seal and the oil seal housing, lightly push down the hex wrench to remove the oil seal housing.

* Be sure to place the screwed side of the container remover on a flat surface when carrying out.

* Be careful not to damage the oil seal housing.

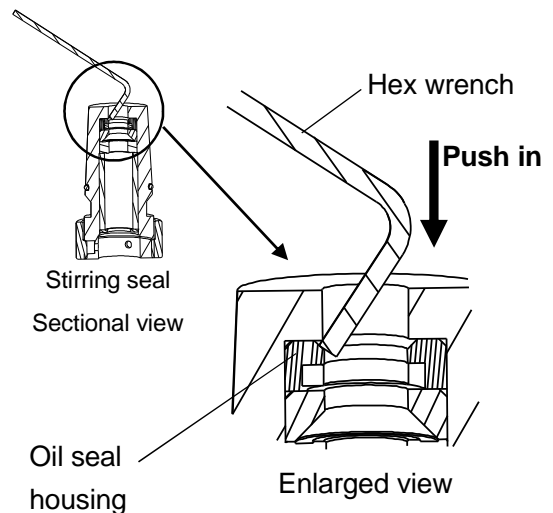

(4) Remove the old oil seal and firmly put the new oil seal in the oil seal housing.

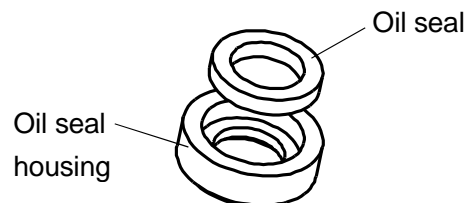

7. MAINTENANCE PROCEDURES

Cleaning and Maintenance

3. Replacing stirring seal parts

■ When the degree of vacuum is lowered
Procedure for changing the oil seal inside the stirring seal

(5) Pass the stirring shaft through the stirring seal and insert it in the order of oil seal, bearing spacer, bearing and spacer. Push the spacer and stirring shaft into the stirring seal and attach the oil seal.

* Since the oil seal housing and the bearing spacer are oriented, check the structure drawing and install it in the correct orientation. Although the standard is made by FKM, a PTFE oil seal with high chemical resistance is also available as an option.

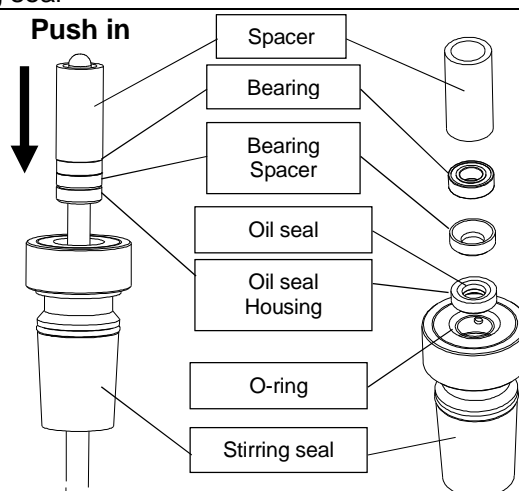

(6) Attach the snap ring.

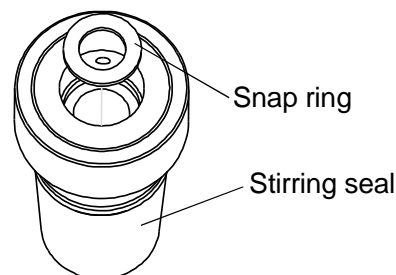

Replacing the O-ring on the outside of the stirring seal
Remove the O-ring on the outside of the stirring seal and replace it with a new one.

* The standard O-ring is made of FKM, but an O-ring made of FFKM with high chemical resistance is also available as an option.

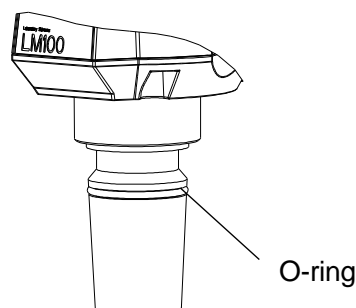

■ When the stirring shaft does not rotate
Replacing bearings inside stirring seal

(1) Refer to steps (1) and (2) above, remove the snap ring from stirring seal.
(2) When turning over the stirring seal, the spacer and bearing will come off. Replace the bearing with a new one.

8. EXTENDED STRAGE AND DISPOSAL



1. Extended storage.



- When unit is out of service during nighttime or placed in storage, turn the speed control dial counterclockwise to OFF, stop the rotation of the stirring blade, and then disconnect the power plug from facility outlet.

2. Unit disposal.



- Dispose of as bulky or industrial waste.
- Do not leave unit in a location where children may have access.

Disposal Considerations

Please conserve the global environment by disposing of or recycling unneeded equipment responsibly. Yamato Scientific Co., Ltd. strongly recommends disassembling unit, as far as is possible, in order to separate parts and recycle them in contribution to preserving the global environment. Major components and materials, comprising this unit are listed in the table below.

Component Name	Material
Exterior Parts	
Exterior, coupling cover	Polybutylene terephthalate
Name plate	Polyethylene
Base, pulley	Aluminum die cast
Drive shaft	Stainless
Belt	Polyurethane
Motor	Iron, copper, aluminum and other compounds
Stirring seal	Teflon
Coupling, coupling screw	PP

9. TROUBLESHOOTING

Troubleshooting Guide

Symptom	Possible causes	Measures
The stirring shaft does not rotate when the speed control dial is turned clockwise.	Is the power cable disconnected from the outlet? Or it may not be inserted securely.	① Turn the speed control dial counterclockwise until it stops, and securely plug the power plug into the outlet.
	There is a possibility that the AC adapter is not inserted securely. Or is the power cable disconnected from the outlet?	② Turn the speed control dial counterclockwise until it stops, and securely connect the power cable into the socket.
	If it does not work even after confirming ②, there is a possibility that the power is not supplied.	③ Turn on the breaker on the switchboard.
	If it does not work even after checking ①②③, there is a possibility that the speed control dial, circuit board, or motor is faulty	Please call for service.
The stirring shaft does not rotate while the power indicator lamp (LM 100/110) or the digital speed indicator (LM 200/210) is	There is a possibility that the board or motor malfunction, disconnection of the motor cable, rotation control part, disconnection of the internal wiring, falling off of the connector.	Stop operation immediately and call for service.
	There is a possibility that the bearings of the stirring seal are rusted.	Replace the bearing according to "7. MAINTENANCE PROCEDURES"(P.19).
	Coupling rubber may be worn out.	Replace the coupling rubber according to "7. MAINTENANCE PROCEDURES"(P.19).
	There is a possibility that the oil seal and stirring shaft are stuck together.	Replace the oil seal and stirring shaft according to "7. MAINTENANCE PROCEDURES"(P.19).
Rotation stopped suddenly.	The motor safety device may have worked. Have you stirred the sample with high viscosity?	Turn the speed control dial counterclockwise to OFF position. Turn the dial clockwise gradually to start stirring again. Keep the rotation speed lower than that unit last stopped.
	Is the power cable disconnected from the outlet?	Turn the speed control dial counterclockwise until it stops, and securely insert the power cable into the socket.
	Is the power supply stopped due to overcurrent?	Turn on the switchboard breaker after turning the speed control dial to OFF.
	Is there a device that generates noise nearby?	Move to an appropriate location to operate unit.
	There is a possibility of breakdown of the board, motor, disconnection of the internal wiring, and falling off of the connector.	Stop operating immediately and call for service.
Abnormal noises are emitted from unit.	Have you stirred high viscous samples or large volume samples? Or have you used large stirring blade?	It may exceed the stirring performance of this unit. Review the conditions of viscosity, capacity, stirring blade, rotation speed and then resume stirring.
	The motor may be faulty.	Stop operating immediately and call for service.
The stirring shaft cannot be drawn when the coupling screw is loosened.	Tightening of the coupling rubber may not loosen or the tightening of the oil seal may not loosen.	Slide the stirring shaft up and down to relieve tightening and then pull out.
Low vacuum degree, vacuum leak. Container will not decompress.	There is a possibility that the oil seal or O-ring wears and the seal cannot be kept.	Replace the oil seal or O-ring according to "7. MAINTENANCE PROCEDURES" (P.19).

10. SERVICE & REPAIR

Request for Repair

Requests for Repair

When a problem occurs, terminate operation immediately, turn the speed control dial to OFF and disconnect power cable. Contact original dealer of purchase for assistance.

< The following information is required for all repairs. >

- Model name
 - Serial number
 - Date (year/month/day) of purchase
 - Description of problem in as much detail as possible
- } Refer to warranty card.

Be sure to present warranty card to Yamato service representative.

Keep warranty card with care. (attached separately)

- Warranty card is given by local dealer or Yamato sales office. Date of purchase of this equipment and other information should be filled in warranty card
- Warranty period is 1 (one) year from date of purchase. Repair this equipment for free of charge according to the contents on warranty card.
- Consult with original dealer of purchase for any repair after warranty ended. Charged repair service of this equipment will be available on customer's request when it can be maintained functional by its repair.

Guaranteed Supply Period for Repair Parts

Guaranteed maximum supply period for repair parts is 7 (seven) years from date of discontinuation for this unit.

"Repair parts" is defined as components which, when installed, allow for continued unit operation.

11. SPECIFICATIONS

Model		LM100	LM110	LM200	LM210
Product name		Flask Mixer			
Operating ambient temperature range		5°C to 35°C			
Performance	Rotation speed range	50 to 1000 rpm: FKM oil seal with PTFE stirring shaft PTFE oil seal with glass or SUS stirring shaft 50 to 300 rpm: FKM oil seal with glass or SUS stirring shaft PTFE oil seal with PTFE stirring shaft			
	Maximum torque	Approx. 0.1 N·m			
	Ultimate vacuum	399.9 Pa or less			
Composition	Exterior	PBT/ADC12 (Surface treatment: Baking finish)			
	Motor	DC brushless motor 30W			
	Power switch	Speed control dial with switch (stepless adjustment)			
	Rotation speed indication	None		3 digits x 10 rpm (digital display)	
	Operation indicator lamp	LED (green)		None (Confirm operation with digital speed indicator)	
Safety function		Overload protection function, coupling cover (Hair entanglement prevention structure), slow start function			
Standard	Recommended container size	50 to 5000 mL			
	Compliant ground joint	J 24/40			
	Correspondence stirring shaft	Dedicated stirring shaft, Commercially available Teflon stirring shaft (Some glass shafts on the market cannot be used.)			
	Correspondence stirring shaft outer diameter	φ8mm			
	Wetted part material	PTFE (ground glass joint)/FKM (oil seal, O-ring)			
	External dimensions	W69xD108xH222			
	Power supply	Voltage: single phase AC100V to 120V/current 1A	Voltage: single phase AC200V to 240V/current 1A	Voltage: single phase AC100V to 120V/current 1A	Voltage: single phase AC200V to 240V/current 1A
Weight	Main body: Approx. 700 g/Accessories: Approx. 500 g				

AC adapter shape specification	
C14	

12. WIRING DIAGRAM

LM100/110 Wiring Diagram

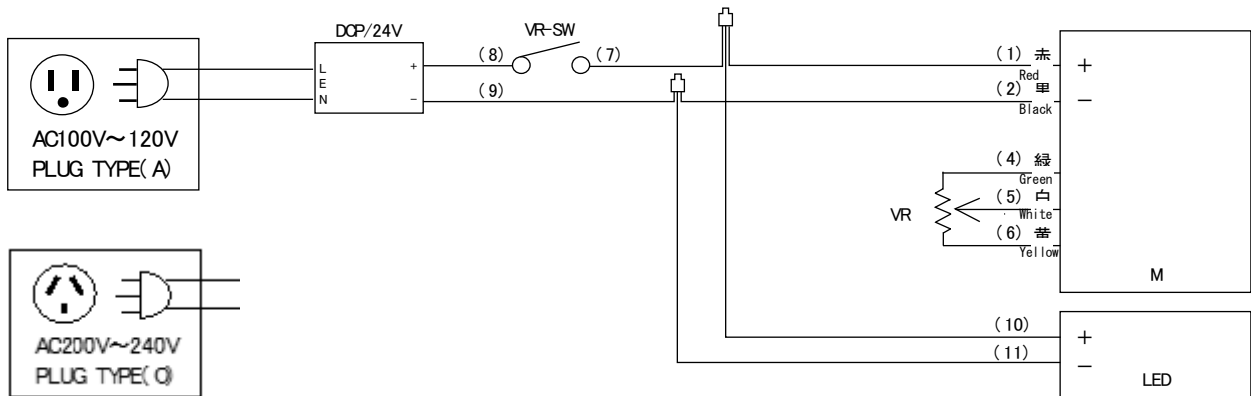

LM200/210 Wiring Diagram

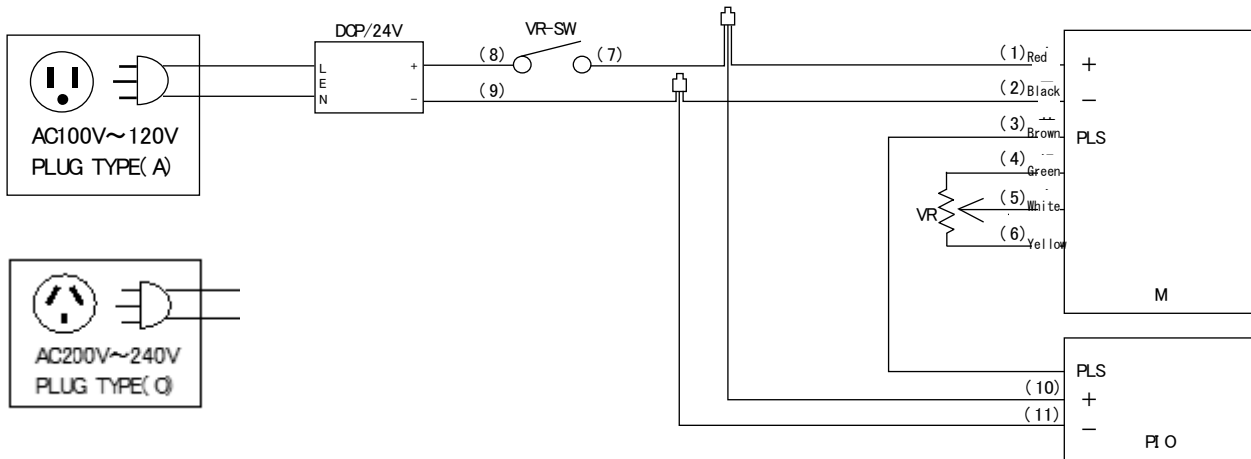

Wiring Diagram Symbol Glossary

Symbol	Component	Symbol	Component
DCP	AC adapter	LED	LED display board
M	Motor	PIO	Rotation speed display board
VR, VR-SW	Speed control dial (with a switch)		

13. REPLACEMENT PARTS LIST

Consumables/Replacement Parts

No.	Product code	Part name	No.	Product code	Part name
1	LM10040170	Coupling screw	12	231641	PTFE oil seal
2	LM10040160	Hitting wheel	13	LM10040190	Oil seal housing
3	LM10040240	Coupling rubber	14	231637	Flask clip (₹ For 29/42)
4	LM10040150	Coupling	15	231638	Flask clip (₹ For 24/40)
5	LM10040230	Container remover	16	LM10040180	Ground glass joint (₹ For 29/42)
6	LM10040220	Snap ring	17	OLM5840000	Ground glass joint (₹ For 24/40)
7	LM10040210	Spacer (₹ For 29/42)	18	LT00038897	FKM O-ring (₹ For 29/42)
8	OLM5840010	Spacer (₹ For 24/40)	19	LT00038898	FKM O-ring (₹ For 24/40)
9	LT00038896	Bearing	20	231642	FFKM O-ring (₹ For 29/42)
10	LM10040200	Bearing spacer	21	231643	FFKM O-ring (₹ For 24/40)
11	231640	FKM oil seal	22	LT00039076	FKM O-ring

* Please refer to the part number and the following sketch drawing for mounting position of each part.

* Refer to "7. MAINTENANCE PROCEDURES" (P.19 & 21)

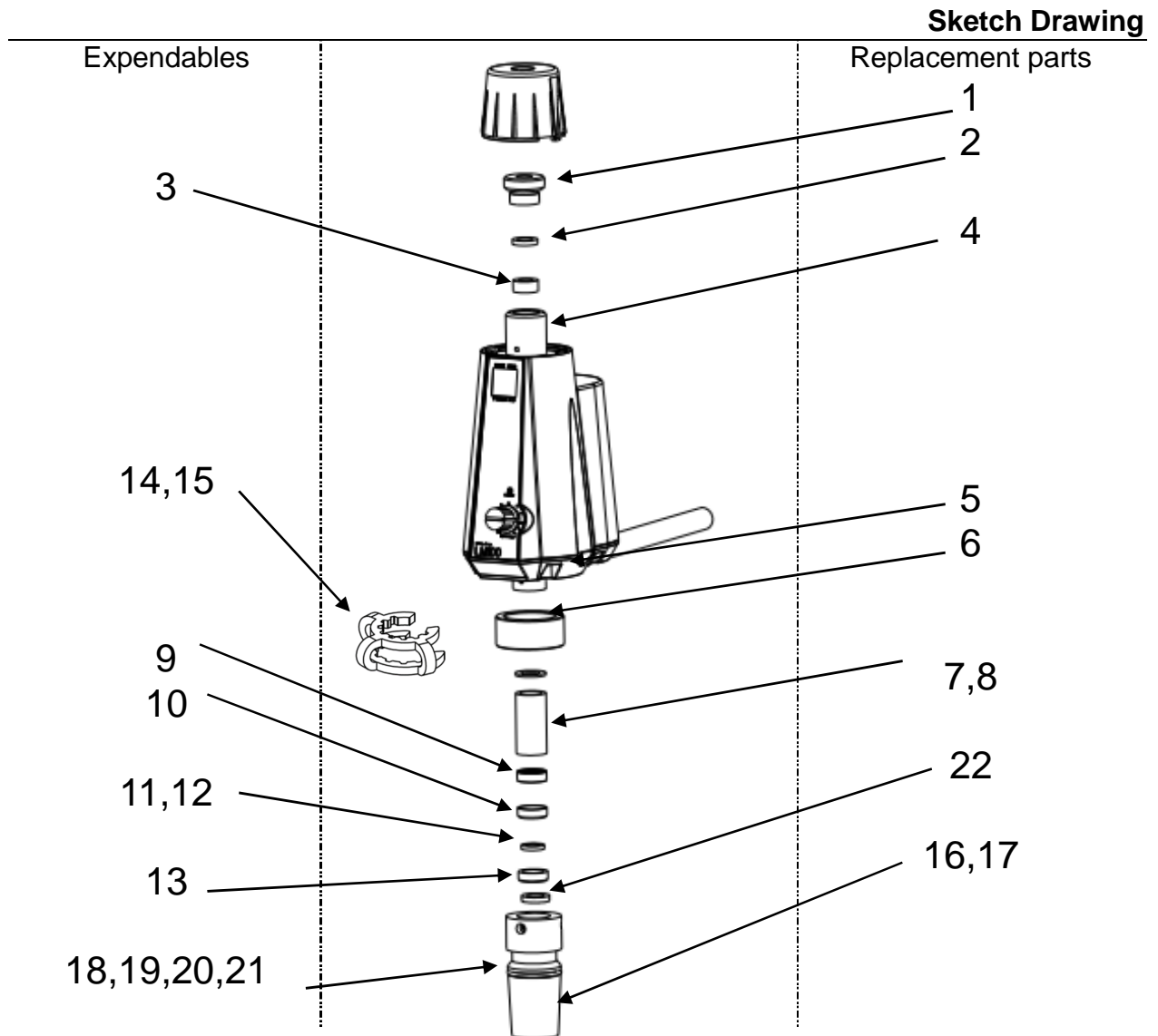

14. LIST OF HAZARDOUS SUBSTANCES



Exercise extreme caution when stirring explosives, flammables or samples containing substances listed below.

Explosive substances	① Nitroglycol, Glycerine trinitrate, Cellulose Nitrate and other explosive nitrate esters
	② Trinitrobenzen, Trinitrotoluene, Picric Acid and other explosive nitro compounds
	③ Acetyl Hydroperoxide, Methyl Ethyl Ketone Peroxide, Benzoyl Peroxide and other organic peroxides
	④ Metallic Azide, including Sodium Azide, etc.
Combustible substances	① Metal "Lithium" ② Metal "Potassium" ③ Metal "Natrium" ④ Yellow Phosphorus
	⑤ Phosphorus Sulfide ⑥ Red Phosphorus ⑦ Phosphorus Sulfide
	⑧ Celluloids, Calcium Carbide (a.k.a, Carbide) ⑨ Lime Phosphide ⑩ Magnesium Powder
	⑪ Aluminum Powder ⑫ Metal Powder other than Magnesium and Aluminum Powder
	⑬ Sodium Dithionous Acid (a.k.a., Hydrosulphite)
Oxidizing substances	① Potassium Chlorate, Sodium Chlorate, Ammonium Chlorate, and other chlorates
	② Potassium Perchlorate, Sodium Perchlorate, Ammonium Perchlorate, and other perchlorates
	③ Potassium Peroxide, Sodium Peroxide, Barium Peroxide, and other inorganic peroxides
	④ Potassium Nitrate, Sodium Nitrate, Ammonium Nitrate, and other nitrates
	⑤ Sodium Chlorite and other chlorites
	⑥ Calcium Hypochlorite and other hypochlorites
Flammable substances	① Ethyl Ether, Gasoline, Acetaldehyde, Propylene Chloride, Carbon Disulfide, and other substances having ignition point of 30 or more degrees below zero.
	② n-hexane, Ethylene Oxide, Acetone, Benzene, Methyl Ethyl Ketone and other substances with ignition point between 30 degrees below zero and less than zero.
	③ Methanol, Ethanol, Xylene, Pentyl n-acetate, (a.k.a. amyl n-acetate) and other substances having ignition point of between zero and less than 30 degrees.
	④ Kerosene, Light Oil, Terebinth Oil, Isopenthyll Alcohol (a.k.a. Isoamyl Alcohol), Acetic Acid and other substances having ignition point of between 30 degrees and less than 65 degrees.
Combustible gases	Hydrogen, Acetylene, Ethylene, Methane, Ethane, Propane, Butane and other gases combustible at 15°C, ambient air pressure.

15. STANDARD SETUP MANUAL

* Install this equipment according to following format. (confirm separately for options or customized specifications)

Model	Serial number	Installation Date	Charged Personnel or Company Name for Installation	Installation proved by	Judgment

No	Item	Implementation method	Chapter No. & Reference page of instruction manual	Judgment
Specification				
1	Accessories	Quantity check according to the accessories column	11. SPECIFICATIONS P.25	
2	Installation	- Visual check of surrounding conditions Caution: Take care for surrounding environment	1. SAFETY PRECAUTIONS P.7 • Choose an appropriate installation site	
		- Securing space		
Operation-related matters				
1	Power-supply voltage	- Measure line voltage (power distribution board of facilities, outlet etc.) with a tester. - Measure line voltage during operation (must meet required voltage). Caution : Use a compliant device to install on ELB.	11. SPECIFICATIONS P.25 • Standard	
Description				
1	Operational descriptions	Explain operations of each component and handling precautions according to instruction manual.	6. OPERATION PROCEDURES P.18	
2	Abnormal signal	Explain about abnormal signs and procedures for reset according to instruction manual.	9. TROUBLESHOOTING- 10. SERVICE & REPAIR P.23-	
3	Maintenance and inspection	Explain about maintenance of equipment and each component according to instruction manual	7. MAINTENANCE PROCEDURES P.19-	
4	Completion of installation Entries	- Fill in Installation Date and Charged Personnel or Company Name on OK and Service label of equipment. - Fill in necessary information to warranty card and hand it over to customer - Explain how to contact with service personnel	10. SERVICE & REPAIR P.24	

Limited Liability

Always operate equipment in strict compliance to the handling and operation procedures set forth by this instruction manual.

Yamato Scientific Co., Ltd. assumes no responsibility for malfunction, damage, injury or death, resulting from negligent equipment use.

Never attempt to disassemble, repair or perform any procedure on LM100/200 Flask Mixer which are not expressly mandated by this manual. Doing so may result in equipment malfunction, serious personal injury or death.

Notice

- Instruction manual descriptions and specifications are subject to change without notice.
- Yamato Scientific Co., Ltd. will replace flawed instruction manuals (pages missing, pages out of order, etc.) upon request.

Instruction Manual
Flask mixer
LM100/110/200/210
Second Edition: October 11, 2017

Yamato Scientific America, Inc.
925 Walsh Avenue, Santa Clara,
CA 95050, U.S.A
<http://www.yamato-usa.com>
Toll Free: 1-800-2-YAMATO (1-800-292-6286)