



Forced Convection Oven

Models

DKN302C/402C/412C

DKN602C/612C

DKN812C

DKN912C

Instruction Manual

First Edition

- Thank you for choosing DKN-C series Forced Convection Ovens from Yamato Scientific Co., Ltd.
- For proper equipment operation, please read and become thoroughly familiar with this instruction manual before use. Always keep equipment documentation safe and close at hand for convenient future reference.

Warning: Read instruction manual warnings and cautions carefully and completely before proceeding.

**Yamato Scientific America Inc.
Santa Clara, CA**

Printed on recycled paper

TABLE OF CONTENTS

1. SAFETY PRECAUTIONS	1
Explanation of Symbols.....	1
Symbol Glossary	2
Warnings & Cautions.....	3
Warnings & Cautions.....	4
2. PRE-OPERATION PROCEDURES	5
Installation Precautions & Preparations	5
3. COMPONENT NAMES AND FUNCTIONS	10
Main Unit	10
Display Characters.....	14
4. OPERATION PROCEDURES	16
Operation Modes and Functions	16
Mode & Function Flow	18
Overheat Prevention Device Setup.....	19
Constant Temperature Mode.....	20
Constant Temperature + Quick Auto Stop Mode.....	21
Auto Stop Mode	22
Programmed Operation.....	26
Pattern Repeat Function	31
Program Planning Worksheet	32
Other Functions: Calibration Offset.....	34
Other Functions: Keypad Lock.....	35
5. HANDLING PRECAUTIONS	36
6. MAINTENANCE PROCEDURES	39
Inspection and Maintenance	39
7. EXTENDED STORAGE AND DISPOSAL	40
Extended Storage / Unit Disposal.....	40
Disposal Considerations	40
8. ERROR CODES	41
Reading Error Codes	41
Troubleshooting Guide.....	42
9. SERVICE & REPAIR	43
10. SPECIFICATIONS	44
11. WIRING DIAGRAM	46
DKN302C/402C/602C.....	46
DKN412C/612C	47
DKN812C	48
DKN912C	49
12. REPLACEMENT PARTS LIST	50
13. HAZARDOUS SUBSTANCES LIST	52

1. SAFETY PRECAUTIONS

Explanation of Symbols

A Word Regarding Symbols

Various symbols are provided throughout this text and on equipment to ensure safe operation. Failure to comprehend the operational hazards and risks associated with these symbols may lead to adverse results as explained below. Become thoroughly familiar with all symbols and their meanings by carefully reading the following text regarding symbols before proceeding

 **Warning** Signifies a situation which may result in serious injury or death (Note 1.)

 **Caution** Signifies a situation which may result in minor injury (Note 2) and/or property damage (Note 3.)

(Note 1) Serious injury is defined as bodily wounds, electrocution, bone breaks/fractures or poisoning, which may cause debilitation requiring extended hospitalization and/or outpatient treatment.

(Note 2) Minor injury is defined as bodily wounds or electrocution, which will not require extended hospitalization or outpatient treatment.

(Note 3) Property damage is defined as damage to facilities, equipment, buildings or other property.

Symbol Meanings



Signifies warning or caution.
Specific explanation will follow symbol.



Signifies restriction.
Specific restrictions will follow symbol.



Signifies an action or actions which operator must undertake.
Specific instructions will follow symbol.

1. SAFETY PRECAUTIONS

Symbol Glossary

WARNING



General Warning



Danger!: High Voltage



Danger!: Extremely Hot



Danger!: Moving Parts



Danger!: Blast Hazard

CAUTION



General Caution



Caution: Shock Hazard!



Caution: Burn Hazard!



Caution: Do Not Heat Without Water!



Caution: May Leak Water!



Caution: Water Only



Caution: Toxic Chemicals

RESTRICTION



General Restriction



No Open Flame



Do Not Disassemble



Do Not Touch

ACTION



General Action Required



Connect Ground Wire



Level Installation

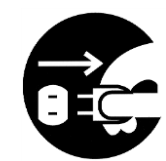

Disconnect Power



Inspect Regularly

1. SAFETY PRECAUTIONS

Warnings & Cautions



NEVER operate equipment near combustible gases/fumes

Do not install or operate DKN-C series unit near flammable or explosive gases/fumes. Unit is NOT fire or blast resistant. Negligent use could cause a fire or explosion. See "List of Hazardous Substances" (P.52)



ALWAYS ground equipment

Always ground equipment properly to avoid electric shock.



DO NOT operate equipment when abnormalities are detected

In the event that smoke or any unusual odor begins emitting from unit, or if any other abnormalities are detected, terminate operation immediately, turn off main power switch (Main Circuit Breaker - "MCB") and disconnect power cable. Continued operation under such conditions may result in fire or electric shock.



DO NOT operate equipment with power cable bundled or tangled

Operating unit with the power cable bundled or otherwise tangled, may cause power cable to overheat and/or catch fire.



DO NOT damage power cable

Damaging the power cable by forcibly bending, pulling or twisting may cause fire or electric shock to the operator.



NEVER process explosive or combustible substances

Attempting to process/use explosive or combustible substances in/near unit may cause explosion or fire. See "List of Hazardous Substances" (P.52)



DO NOT touch hot surfaces.

Some surfaces on this unit become extremely hot during operation. Exercise vigilance in order to avoid getting burned.



NEVER disassemble or modify the equipment

Attempting to dismantle or modify unit in any way, may cause malfunction, fire or electric shock.



DO NOT insert multiple power cables into a single outlet

Inserting multiple cords into a single outlet, using branch outlets or extension cords, may cause power cable to overheat and/or catch fire. Other issues may include a drop in voltage, which may affect performance, resulting in failure to control or maintain proper temperature.

1. SAFETY PRECAUTIONS

Warnings & Cautions



Caution



Moving unit to install location

Always carry unit to install location using cargo handling equipment, such as a forklift. Unit casters (DKN812C/912C only) are intended only to facilitate short-distance maneuvering at installation site. Do not roll unit over extended distances on casters. Damage to the casters may result.



DO NOT operate equipment during thunderstorms

In the event of a thunderstorm, terminate operation and turn off main circuit breaker (MCB) immediately. A direct lightning strike may cause damage to equipment, or result in fire or electric shock.

2. PRE-OPERATION PROCEDURES

Installation Precautions & Preparations



1. Ground wire MUST be connected properly



DKN302C/DKN402C/DKN602C models are rated for 115V AC power supply.

- Ground wire must be connected to a proper grounding line or terminal in order to prevent electric shock.
- Never connect ground wire to gas lines or water pipes.
- Never connect ground wire to telephone grounding lines or to lightning conductor rods. Doing so may result in fire or electrical shock.
- Never insert multiple plugs into a single outlet. Doing so may result in power cable overheating, fire or drop in voltage.

Connect power cable to grounded outlet!

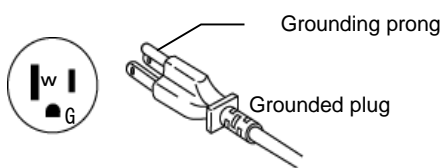

- DKN412C/612C/812C/912C models are rated for 220V AC power supply. Before connecting these models, confirm facility power supply is set up to properly deliver required voltage supply.

2. Choose an appropriate installation site



DO NOT install unit:

- where installation surface is not completely level, not even or not clean.
- where flammable or corrosive gases/fumes may be present.
- where external temperature will exceed 35°C, will fall below 5°C or will fluctuate.
- in excessively humid or dusty locations.
- where there is constant vibration.
- where power supply is unstable or erratic.
- in direct sunlight or outdoors.



Install DKN-C series unit in a location with sufficient space, as specified as below. DKN302C/402C/412C/602C/612C are equipped with exhaust ports in top panel. DKN812C/912C are equipped with exhaust ports in rear panel. Be sure these ports remain unobstructed with adequate space to dissipate outgoing heat.

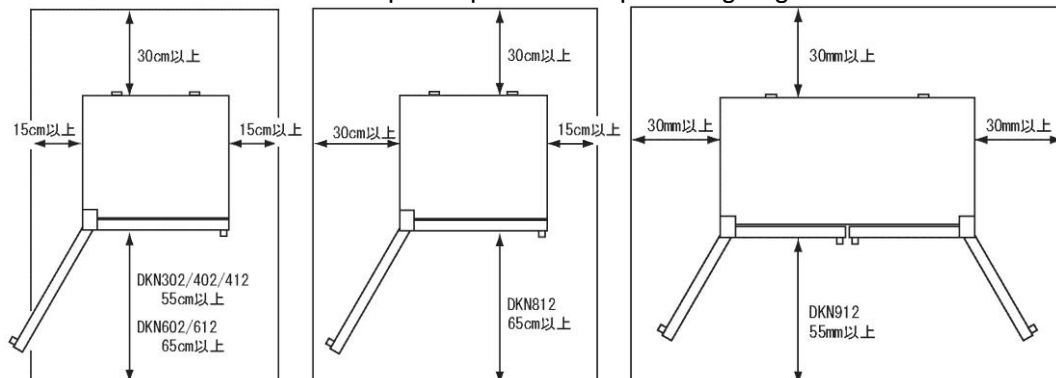

2. PRE-OPERATION PROCEDURES

Installation Precautions & Preparations



3. Install in a location free of flammables and explosives



Never install near flammables or explosives of any kind. This unit is NOT fire or blast resistant. Simply switching the main circuit breaker (MCB) "ON" or "OFF" can produce a spark, which can then be relayed during operation, causing a fire or explosion when near flammable or explosive fluids, chemicals or gases/fumes. See "List of Hazardous Substances" (P.52)

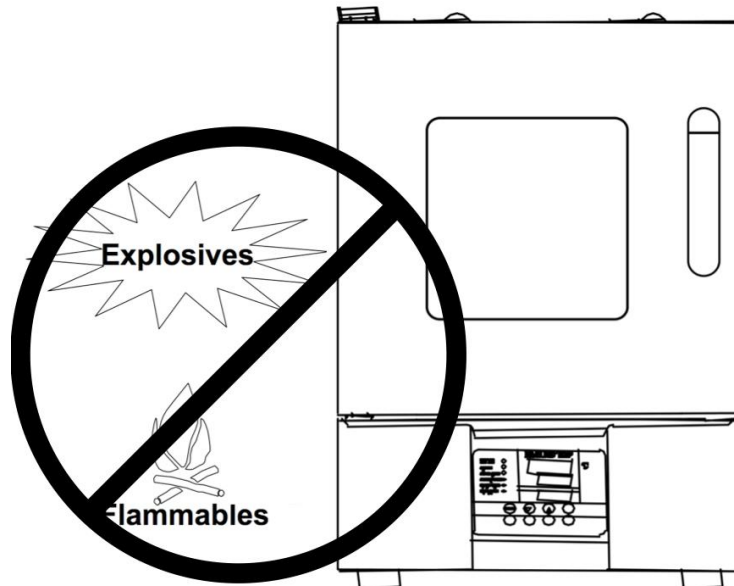

Never process explosive or flammable substances in unit. Fire or explosion, causing serious injury or death may result. See "Hazardous Substances List (P.52) for more information on these substances.

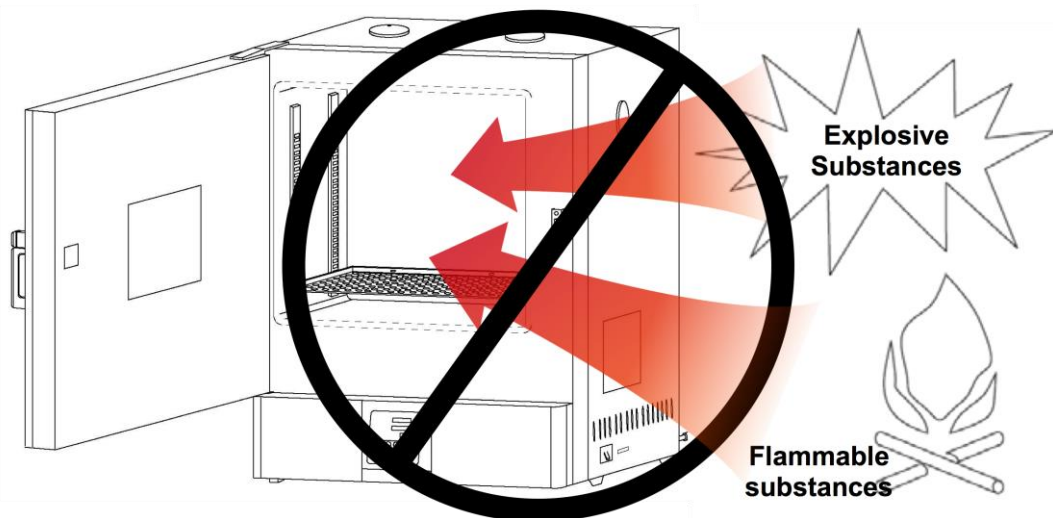

2. PRE-OPERATION PROCEDURES

Installation Precautions & Preparations



Warning

4. Never disassemble or modify



Never attempt to disassemble or modify this unit. Doing so may cause equipment malfunction, fire or electric shock.



5. Install on a level surface



Install unit on level and even surface. Failure to do so may cause abnormal vibrations or noise, resulting in possible complications and/or malfunction.

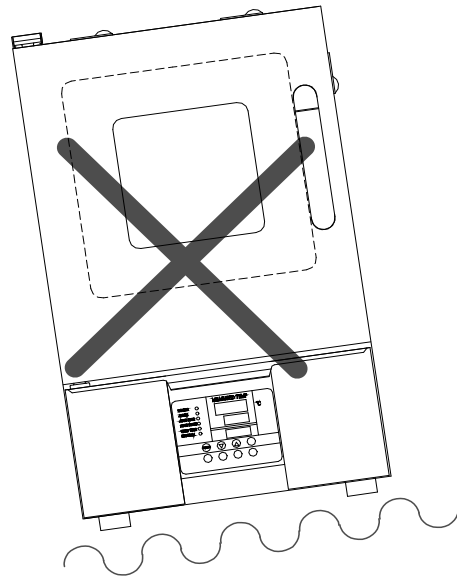

6. Do not overload chamber racks



Maximum load for unit racks is 15kg each, when load is evenly distributed. Place items as evenly and as far apart as possible and do not exceed maximum load rating.



7. Space test samples appropriately



Bunching items together to get more onto a rack may prevent proper temperature control. As a rule of thumb, use approximately 70% of entire rack space or less, when placing items, to ensure better temperature control accuracy.

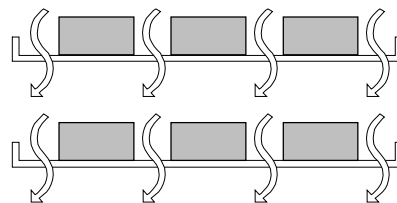

2. PRE-OPERATION PROCEDURES

Installation Precautions & Preparations



8. Connect to a proper power source



- Use a dedicated power supply that matches electrical capacity.

Electric capacity:	DKN302C	115V AC	8.5 A (MCB capacity 20A)
	DKN402C	115V AC	12.5A (MCB capacity 20A)
	DKN602C	115V AC	14A (MCB capacity 20A)
	DKN412C	220V AC	6.5A (MCB capacity 20A)
	DKN612C	220V AC	7A (MCB capacity 20A)
	DKN812C	220V AC	12.5A (MCB capacity 20A)
	DKN912C	220V AC	15.5A (MCB capacity 20A)

Connecting multiple cables to an outlet or using a branch outlet or extension cord will cause voltage to drop, leading to degraded temperature control, and in extreme cases, overheating or fire.

Be advised that maximum operating temperature (DKN302C/402C/602C/412C/612C/812C - 260°C, DKN912C - 210°C) may not be reached under low external temperatures, if source voltage is below 115V (DKN302C/402C/602C) / 220V (DKN412C/612C/812C/912C).

9. Secure unit on installation surface



- Unit may tip over or fall, causing injury or death during an earthquake or other unforeseen incident. Be sure to stabilize unit properly (adjustable leveling feet securely positioned, etc.) to assure safe operation and a safe work area.

Be sure casters are locked in place on DKN812C/912C models.

Install supplied caster holders (DKN812C/912C only) as shown below:

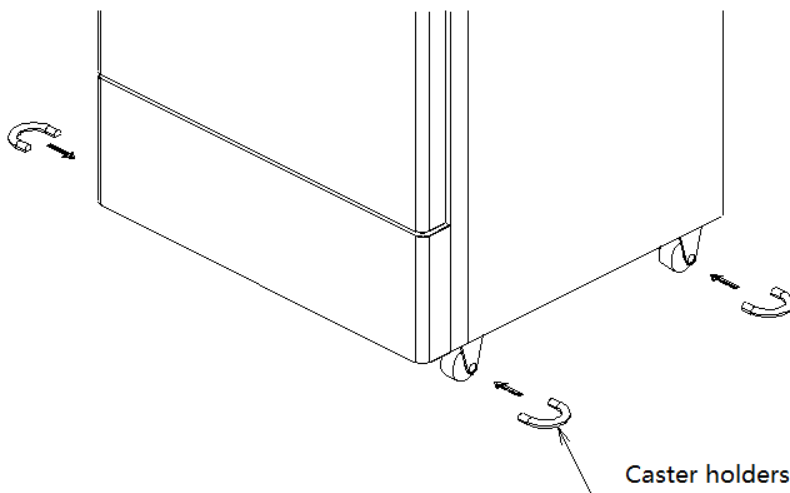

10. Initial operation



When operating for the first time some, some atypical odors may emit from unit which are the result of burn-off from heat insulation, bonding material, etc., and is normal. These odors will subside with further use.

2. PRE-OPERATION PROCEDURES

Installation Precautions & Preparations



CAUTION

11. Chamber rack and test sample placement



Chamber rack capacity differs by model. Number of supplied racks is 2-8.

Bottom-most rack (two for DKN912C) is secured by screws. All other racks may be placed as desired.

Unit heater is located directly under diffuser panel (chamber floor), causing this surface to be higher in temperature than all other interior surfaces. Placing sample items directly on diffuser panel may cause samples to be damaged, burned or catch fire. To minimize fire and safety hazards, do not remove these screws and leave bottom-most rack secured in place.

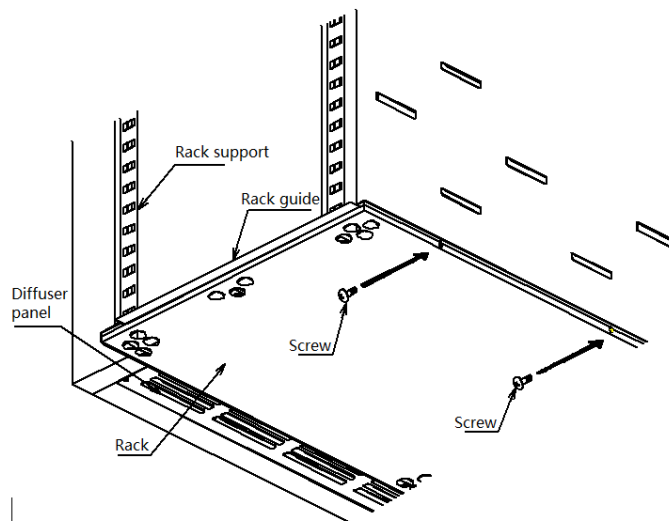

12. Handle power cable with care



● Never operate this unit with power cable bundled or tangled; and do not modify, bend, forcibly twist or pull on power cable. Doing so may cause fire and/or electrical shock.

● Do not risk damage to power cable by positioning it under desks or chairs, or by allowing it to be pinched between objects. Doing so may cause fire and/or electrical shock.

● Do not place power cable near kerosene/electric heaters or other heat-generating devices. Doing so may cause power cable insulation to overheat, melt and/or catch fire, which may result in electric shock.



● Turn off main circuit breaker (MCB) immediately and disconnect from facility terminal or outlet, if power cable becomes partially severed or damaged in any way. Failure to do so may result in fire or electric shock.

Contact a local dealer or Yamato sales office for information about replacing power cable if it becomes damaged.

● Always connect power cable to appropriate facility outlet or terminal.

3. COMPONENT NAMES AND FUNCTIONS

Main Unit

DKN302C/402C/412C/602C/612C

Front view

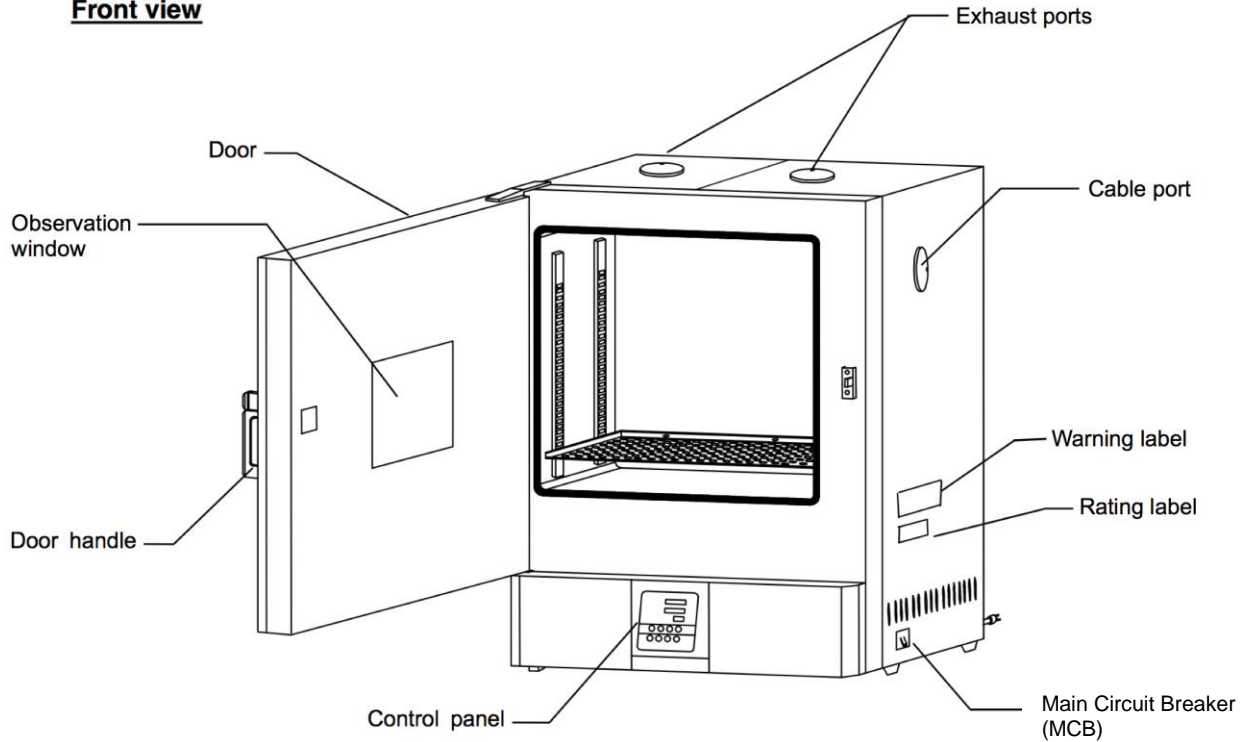

Rear view

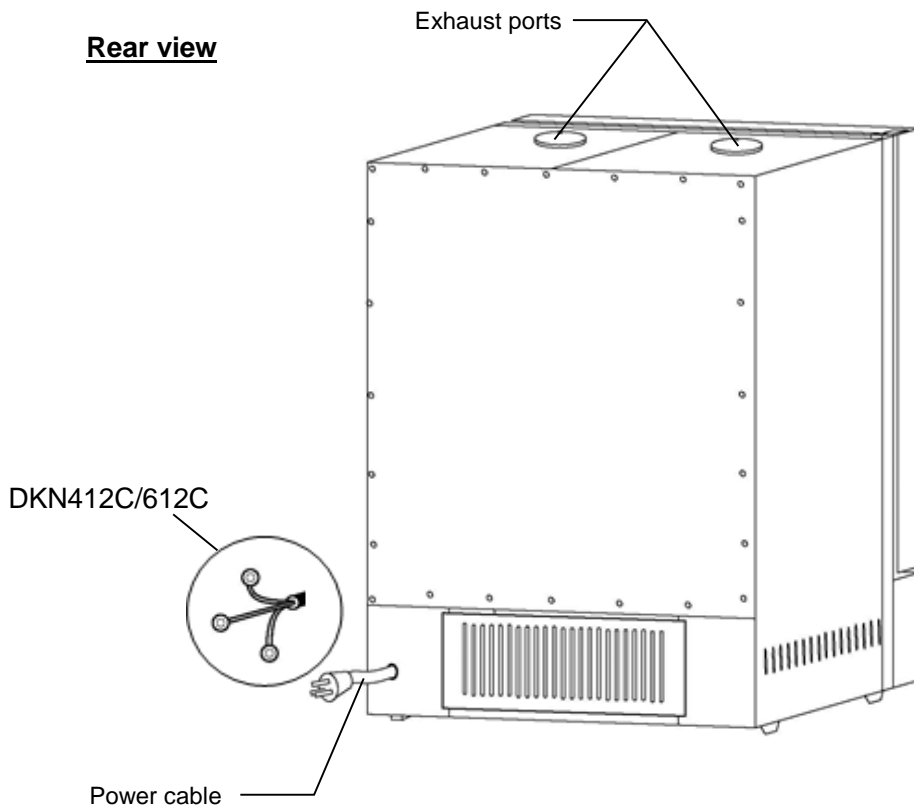

3. COMPONENT NAMES AND FUNCTIONS

Main Unit

DKN812C

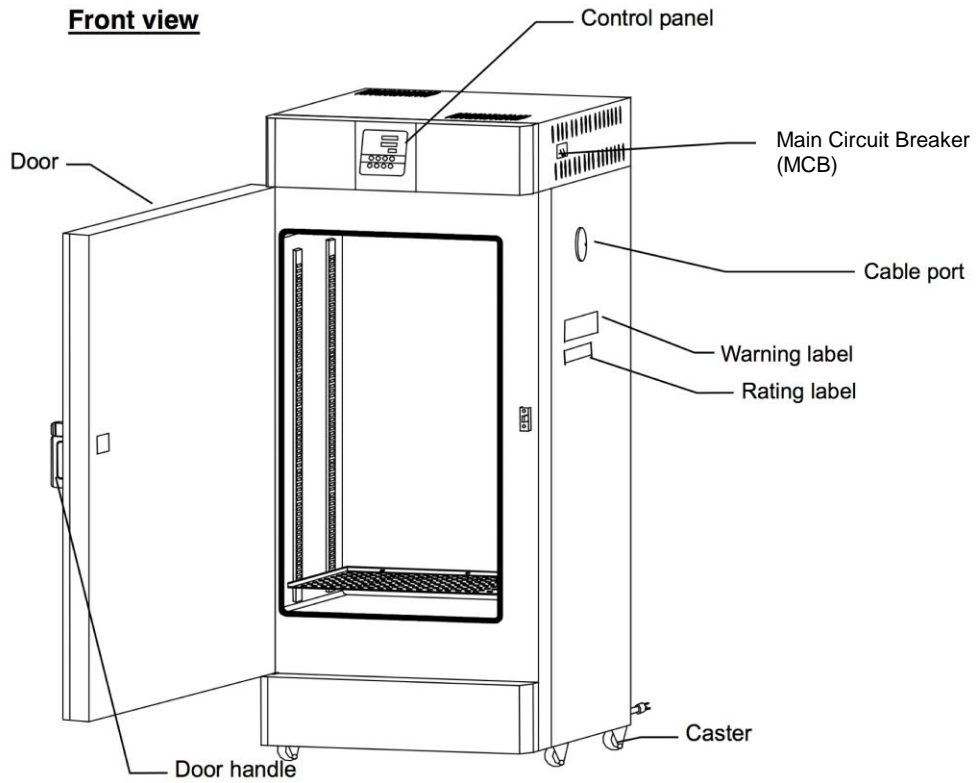

Rear view

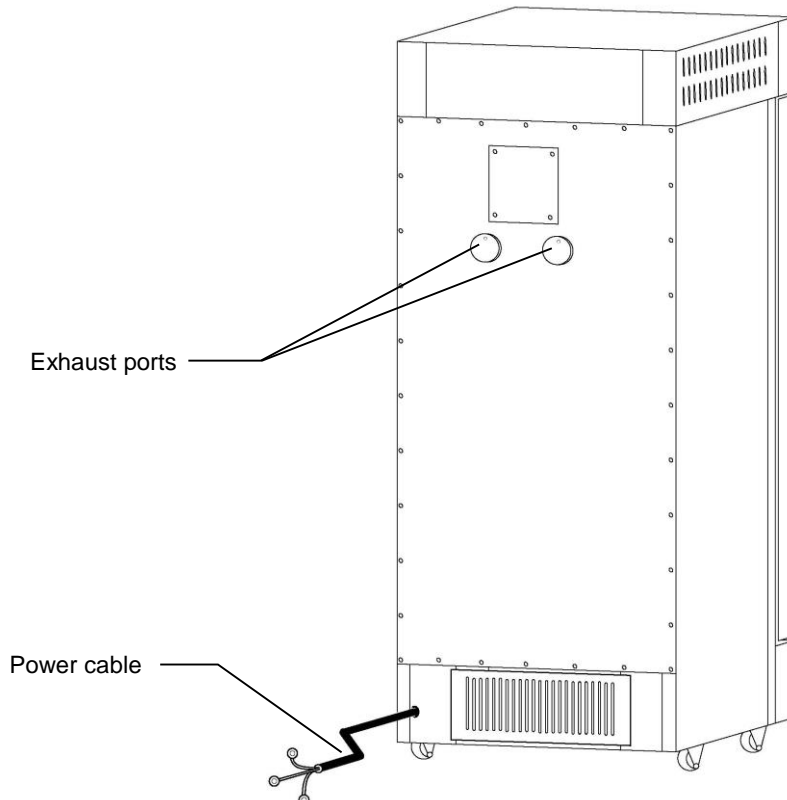

3. COMPONENT NAMES AND FUNCTIONS

Main Unit

DKN912C

Front view

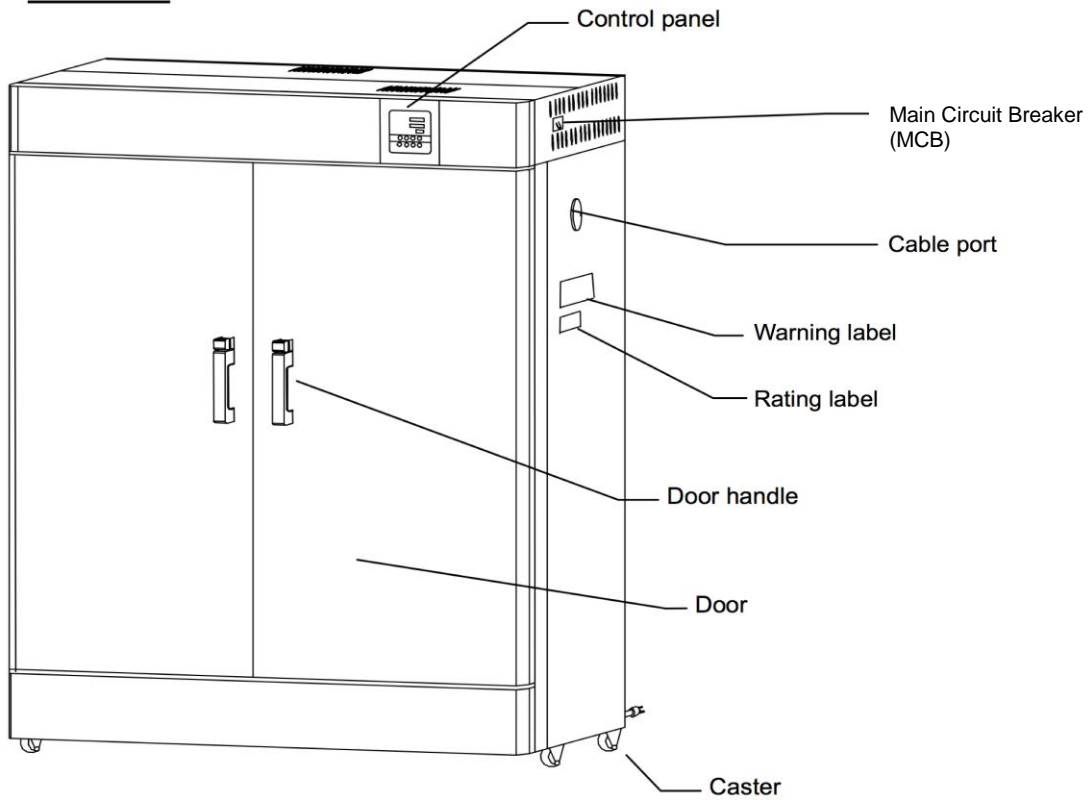

Rear view

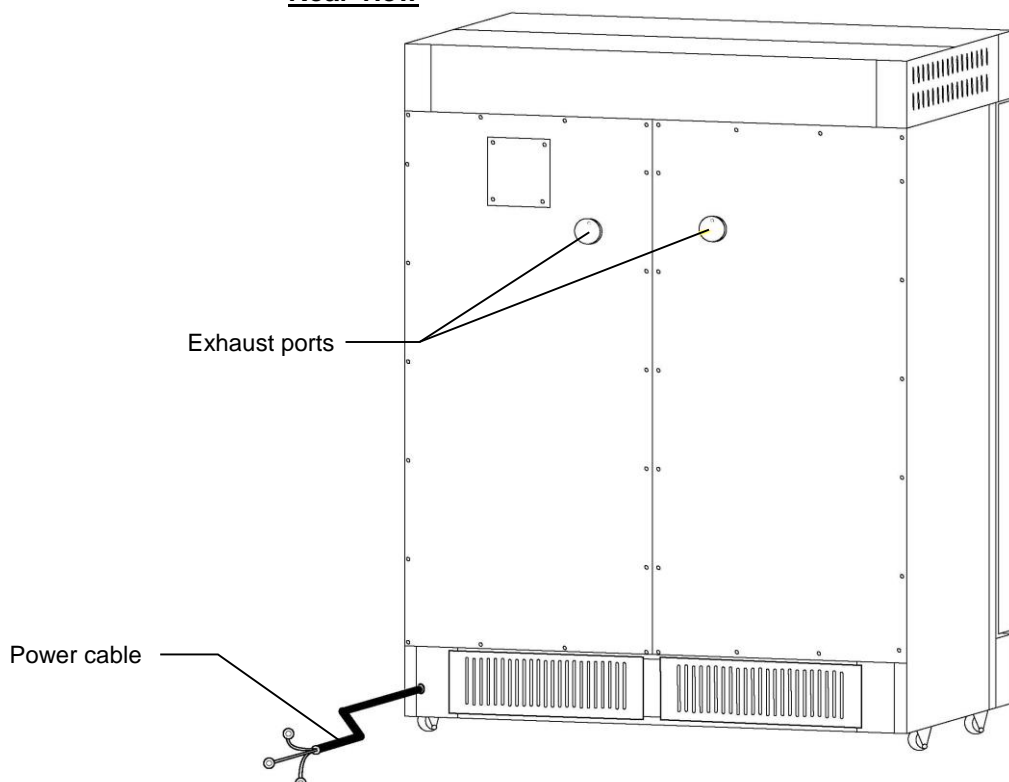

3. COMPONENT NAMES AND FUNCTIONS

Main Unit

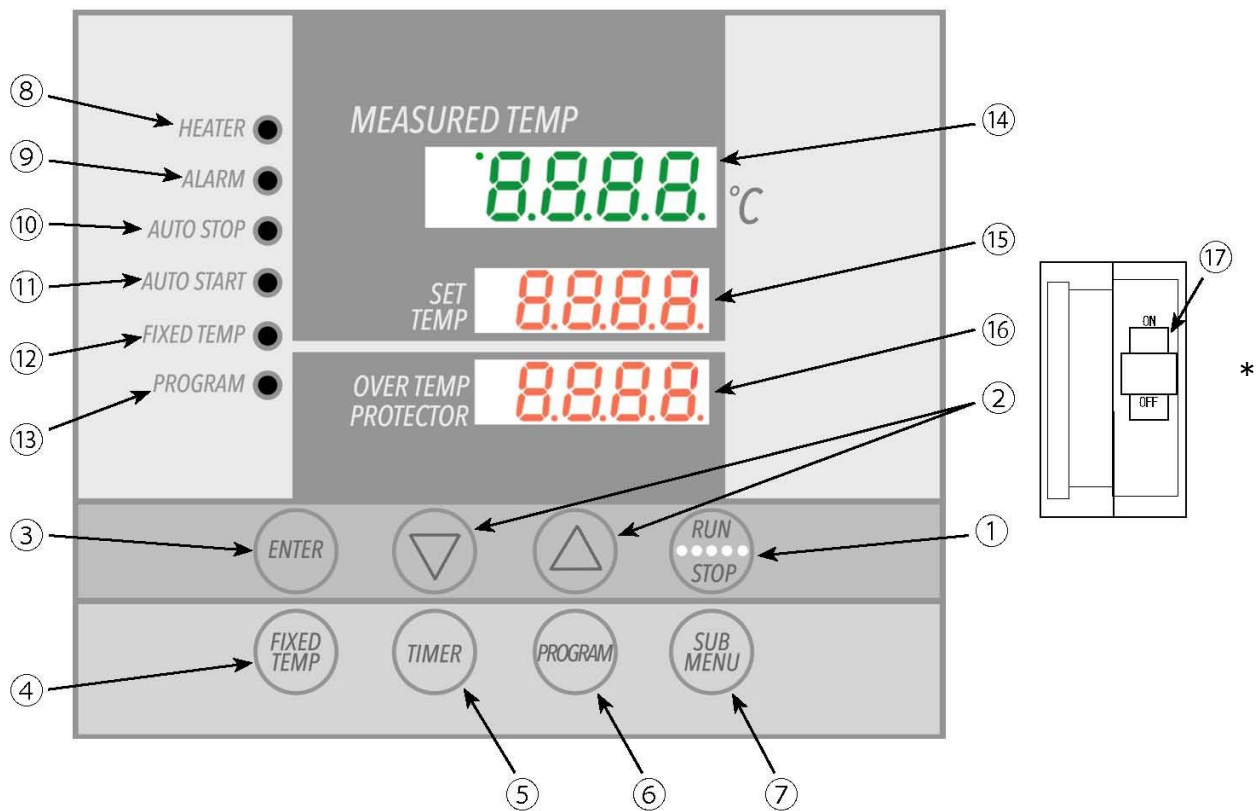







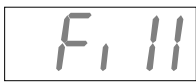

No.	Panel Item	Description
1	RUN/STOP Key	Press to start or stop an operation.
2	Up/Down Arrow Keys	Press repeatedly to increase or decrease setting value incrementally. Press and hold to increase or decrease setting value perpetually.
3	ENTER Key	Press to finalize setting.
4	FIXED TEMP Key	Press to select FIXED TEMPERATURE mode.
5	TIMER Key	Press to select timed operation. Quick Auto Stop, Auto Stop or Auto Start modes may be selected.
6	PROGRAM Key	Press to begin creating programs or to select programmed operation. 3 programs with a total of 6 patterns may be set. (See P.25)
7	SUBMENU Key	Press to enter overheat prevention temp setting, calibration offset, keypad lock, and program repeat menus.
8	HEATER Indicator Lamp	Illuminates when heater is on and drawing power.
9	ALARM Indicator Lamp	Illuminates when an error occurs (accompanying alarm tone sounds).
10	AUTO STOP Indicator Lamp	Illuminates while Auto Stop operation is in progress. Flashes while setting Quick Auto Stop or Auto Stop modes.
11	AUTO START Indicator Lamp	Illuminates while Auto Start operation is in progress. Flashes while setting.
12	FIXED TEMP Indicator Lamp	Illuminates while Fixed Temperature operation is in progress. Flashes while setting.
13	PROGRAM Indicator Lamp	Illuminates while Programmed operation is in progress. Flashes while setting.
14	Main Display (Temp reading display)	Shows current chamber temperature, setting characters and error information.
15	Subdisplay (Temp setting display)	Shows temperature setting, timer setting and remaining time.
16	Overheat Prevention Display	Shows overheat prevention temperature limit setting.
17	Main Circuit Breaker (MCB)	Flip up or down to turn unit ON or OFF respectively.

3. COMPONENT NAMES AND FUNCTIONS

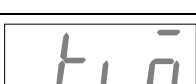
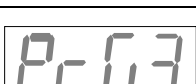

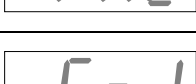
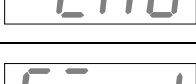
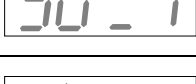
Display Characters

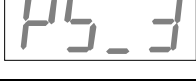
All characters displayed when making settings and during operation are defined as follows:

Character	Identifier	Description	Purpose
	Fix	Signifies constant temperature setting mode	Appears while entering settings for constant temperature operation.
	Sv	Signifies temperature setting mode	Appears while entering temperature settings.
	ASStP	Signifies auto stop and quick auto stop setting mode	Appears while entering settings for quick auto stop or auto stop mode.
	ASStR	Signifies auto start setting mode	Appears while entering settings for auto start mode.
	tim	Signifies timer setting mode	Appears while entering timer settings.
	PrG3	Signifies which program is being set	Appears when selecting which program to use (1, 2 or 3) See "Programmed Operation" (P.26)
	PAt	Signifies program pattern	Appears when selecting a program pattern. See "Programmed Operation" (P.26)
	End	Signifies end of a timed operation	Appears when a timed operation is completed. See pgs. 19~23
	Sv-1	Signifies which step temperature is being set	Appears while setting temperature for each step in a program. (Sv-1 to Sv-30)
	t-1	Signifies which step timer is being set	Appears while setting timer for each step in a program. (t-1 to t-30)
	PS-3	Signifies what step is to be repeated	Appears when selecting step numbers to be repeated in a program. See "Pattern Repeat Function" (P.31)
	Pc-2	Signifies number of times to repeat	Appears when setting the number of times to repeat steps in a program. See "Pattern Repeat Function" (P.31)

3. COMPONENT NAMES AND FUNCTIONS

Display Characters

Character	Identifier	Description	Purpose
	cAL	Signifies calibration offset setting mode	Appears while entering offset temperature values. See "Calibration Offset" (P.34)
	oH	Signifies overheat prevention setting mode	Appears while setting activation temperature for overheat prevention device. See "Overheat Prevention Device Setup" (P.19)
	Lock	Signifies that keypad is locked	Appears while control panel keypad is locked. See "Keypad Lock" (P.35)

4. OPERATION PROCEDURES

Operation Modes and Functions

Operation modes for this unit are defined in the table below:

N o.	Name	Description	Page
1	Constant Temperature Mode	Pressing the FIXED TEMP key brings up constant temperature setup mode. The "▲▼" keys are used to set temperature. Pressing the RUN/STOP key initiates or terminates operation.	20
2	Quick Auto Stop Mode	This mode is used to automatically terminate an operation when a specified time period has passed (decided during operation). This is done by pressing the TIMER key at any time during constant temperature operation. The "▲▼" keys are used to set the timer. Pressing the RUN/STOP key begins operation in quick auto stop mode, activates the timer (once temp setting is reached) and automatically terminates operation when timer reaches 0:00.	21
3	Auto Stop Mode	This mode is used to automatically terminate an operation when a specified time period has passed (decided before operation). Pressing the TIMER key displays "AStp". The temperature (Sv) is set by pressing the ENTER key. The operation time (tim) is set by pressing ENTER again. Pressing the RUN/STOP key begins operation in auto stop mode. Operation automatically terminates when timer reaches 0:00.	22
4	Auto Start Mode	This operation is used to automatically begin an operation after a specified period has passed. Pressing the TIMER key displays "AStr". The temperature (SV) is set by pressing the ENTER key. The operation time (tim) is set by pressing ENTER again. Pressing the RUN/STOP key begins operation in auto start mode.	24
5	Programmed Operation	This operation is used to run a combination of modes, times and temperatures as one operation. Pressing the PROGRAM key displays "PrG1". Press it again to select program mode. Press the ENTER key to select the pattern (Pat). Press the ENTER key to display "End". Enter the number of patterns to be used. Enter step temperatures and step times for "Sv_x" and "t_x" respectively (where "x" stands for a number or value).	26
* It is not possible to change modes during operation. If a mode change is required, operation must be terminated and a new mode of operation must be set.			

4. OPERATION PROCEDURES

Operation Modes and Functions

Operation functions for this unit are defined in the table below:

No	Name		Description	Page
1	Overheat prevention	Auto overheat prevention	This function is set to automatically activate (auto reset) when chamber temperature exceeds the temperature setting by 12°C.	19
		Overheat prevention device	Although this device uses the same power source, display, and keypad as the control panel, it has an independent temperature monitoring circuit, CPU, sensor and output circuit. An overheat prevention temperature can be manually specified using the control panel. Unit operation is terminated when device is activated. Operation may be restarted when the main circuit breaker (MCB) is switched off (wait 5 seconds), then back on again (manual reset).	
2	Calibration offset		Calibration offset function is to compensate for differences in the temperature reading (as taken by unit sensor) and actual chamber temperature (as taken manually with a thermograph). Unit can be offset to either the positive or negative side of temperature line for entire temperature range of unit	34
3	Overheat prevention temperature calibration function		The temperature specified for the overheat prevention device is automatically recalibrated when temperature reading is corrected with the calibration offset function.	—
4	Power failure recovery		Unit can begin operation again with the same settings (in memory) as before the power failure occurred. Simply press the START/STOP key to begin the operation over from the beginning.	—
5	Keypad lock		This function locks all keys (except SUBMENU and START/STOP) during operation. Lock function is set or cancelled using the SUBMENU key.	35

4. OPERATION PROCEDURES

Mode & Function Flow

The following chart illustrates the flow of modes and functions.

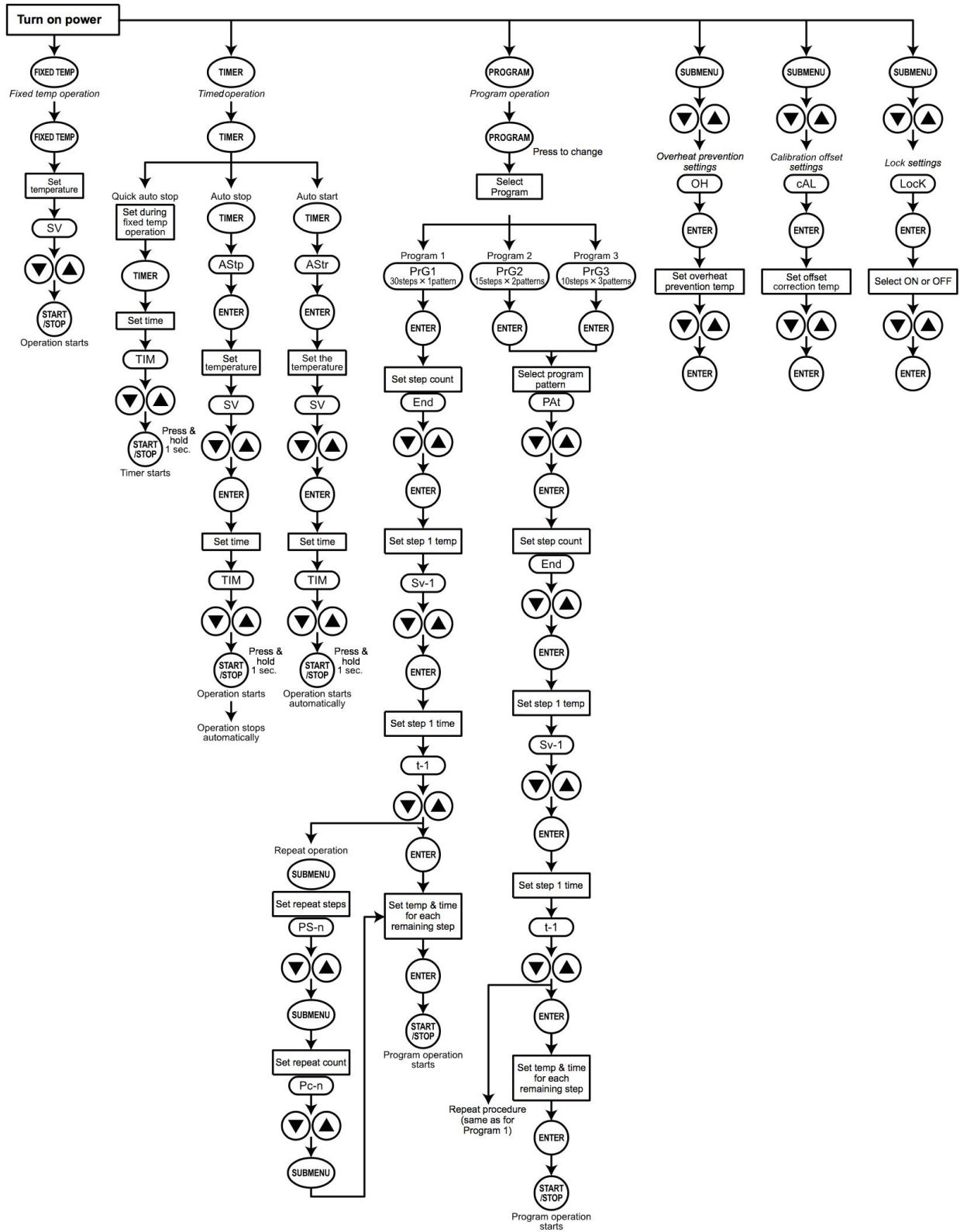

4. OPERATION PROCEDURES

Overheat Prevention Device Setup

This unit features an overheat prevention device (manual reset) which, has an independent temperature monitoring circuit, CPU, sensor and output circuit, but uses the same power source, display, and keys as the control panel. This is in addition to the internal automatic overheat prevention function (auto reset), built in for added measure against overheating.

Setting range/function

The automatic overheat prevention function (auto reset) is integrated internally into the unit and is set to automatically activate (cutting off power to heater) when chamber temperature exceeds temperature setting on control panel by 12°C or more.

The overheat prevention device temperature setting range is from 0°C to 50°C beyond the maximum temperature setting for DKN-C series units.

When chamber temperature exceeds objective temperature setting and reaches that of the overheat prevention device, the circuit is shut off and error code "Er19" is shown flashing in the control panel display, accompanied by a sounding alarm.

Once activated, "Er19" continues to be displayed until main circuit breaker (MCB) is turned off (wait 5 seconds) then back on.

Setting temperature for overheat prevention

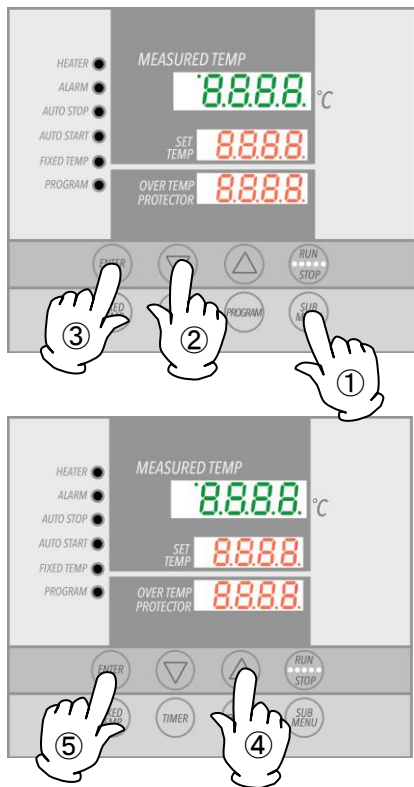

1. Turn on main circuit breaker (MCB).
Default values are displayed for about four seconds.

Turn on power. Displays will show initial settings. Current chamber temperature (top), main temperature setting (center) and temperature setting for overheat prevention device (bottom) will show in respective displays.

2. Set temperature for overheat prevention

- ① Press the **SUBMENU** key.
- ② Press the **▼▲** several times until **oH** is shown in the top display.
- ③ Press the **ENTER** key. The temperature setting will be shown flashing in center display.

Note: To prevent false errors, set the value 10°C or more above the main temperature setting.

- ④ Select value using the **▼▲** keys and press the **ENTER** key. Setting value will show in the bottom display. This completes the setting.
- ⑤ Press **ENTER**

CAUTION

- ① The standard setting temperature of device is "maximum unit temperature setting of plus 20°C" or "temperature setting plus 20°C". If unit performs poorly, increase by 5°C more.
- ② Note that improper temperature settings may cause malfunction resulting in equipment damage or fire. Always use appropriate temperature settings.
The factory default setting for overheat prevention device is 290°C (DKN912C is 240°C). Do not attempt to set value higher.
- ③ Overheat prevention device is designed to protect unit against overheating, not to protect test samples against damage caused by overheating, nor to protect against injury or death resulting from negligence from processing explosives, inflammables or other hazardous substances in this unit.

4. OPERATION PROCEDURES

Constant Temperature Mode

Constant temperature operation procedure

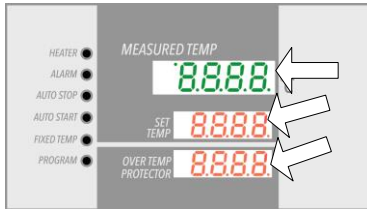

1. Turn on the main circuit breaker (MCB)

- ❖ Default values are displayed for about four seconds after turning on power. Initial settings will then show in respective displays.

Temperature monitoring display:

Shows current temperature in the chamber and other setting information.

Main temperature setting display:

Shows temperature setting and other setting information.

Overheat prevention display:

Displays the temperature setting of overheat prevention device.

(For more on mode and setting characters, see “Display Characters”, P.14)

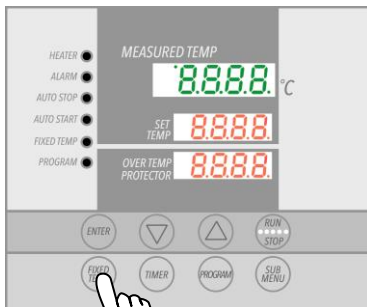

2. Select operation mode

Press the **FIXED TEMP** key to display **Fi ll**, indicating constant or “FIX” temperature mode, in center display.

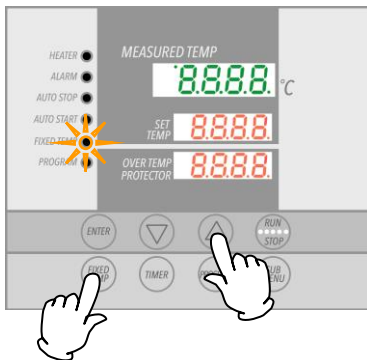

3. Set temperature

Center display shows **50**, indicating temperature can be set. Current temperature will flash in top display. **FIXED TEMP** lamp also flashes.

Set temperature using the **▼▲** keys.

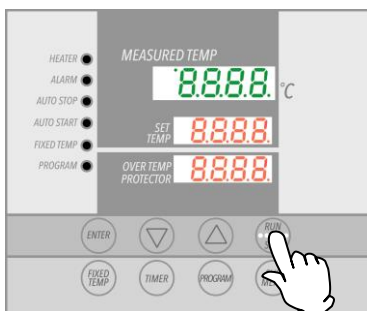

4. Start operation

Press the **RUN/STOP** key for about one second. Unit will begin operation and **FIXED TEMP** lamp will change from flashing to constant to indicating that unit is currently operating in constant temperature mode.

5. Stop operation

Press the **RUN/STOP** key for about one second. Operation will stop (terminate) and the **FIXED TEMP** lamp will go out. Control panel reverts to initial settings screen.

Editing or confirming settings.

Press the **FIXED TEMP** key again to edit or confirm settings.

Changing the temperature setting during operation is also possible using the **FIXED TEMP** key. When setting changes have been made, press the **ENTER** key to finish.

4. OPERATION PROCEDURES

Constant Temperature + Quick Auto Stop Mode

Quick auto stop operation procedure

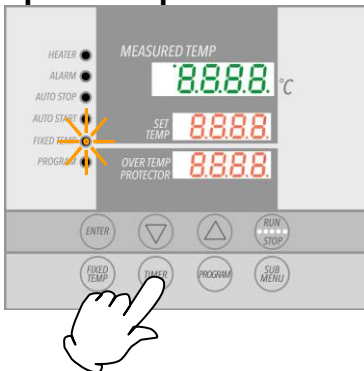

This mode is used to specify when unit should terminate constant temperature operation. This mode is set during operation only.

1. Set timer during constant temperature operation

Confirm that unit is operating by confirming that FIXED TEMP lamp is illuminated.

Press the **TIMER** key.

Top display will show **tin**, indicating that the timer can be set. Current timer setting will flash in center display.

Set the timer using the **▼▲** keys.

Timer function:

Maximum value for timer is "999 hours and 50 minutes".

The time can be set in increments of one minute, under 99 hours and 59 minutes.

Setting increments are 10 minutes, after 100 hours.

When **▼▲** keys are held down, values advance perpetually. Press repeatedly for incremental adjustment.

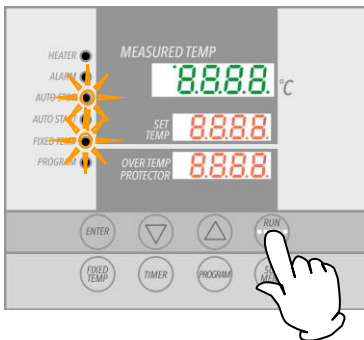

2. Start quick auto stop operation

Press the **RUN/STOP** key for about one second after setting timer.

FIXED TEMP and AUTO STOP lamps will illuminate, indicating quick auto stop operation mode has started.

To manually stop/terminate quick auto stop operation

Operation stops automatically when timer reaches 0.00, and an accompanying alarm sounds for approximately five seconds after operation terminates.

Center display will show **End**, indicating end of operation, with FIXED TEMP and AUTO STOP lamps illuminated. Press **RUN/STOP** key to at any time during operation or after operation ends, to terminate quick auto stop operation mode. Displays will return to initial settings screen.

Editing or confirming settings

Changing Temperature during operation is possible by pressing the **FIXED TEMP** key. Press the **ENTER** key after changing temperature setting.

Changing the timer setting during operation can be done without terminating operation, simply by pressing the **TIMER** key. Note that this will require adding additional time to the elapsed time. Press the **RUN/STOP** key when changes have been entered, as desired. Press the **▼** key at any time thereafter to see temperature setting, operation mode and remaining time in the center display.

4. OPERATION PROCEDURES

Auto Stop Mode

Auto stop operation procedure

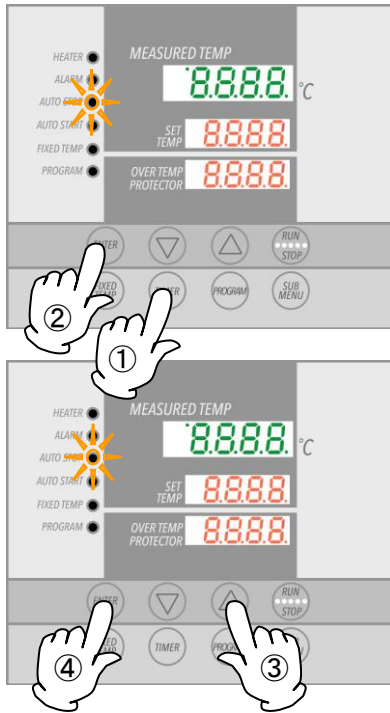

This mode is used to specify when unit should terminate constant temperature operation. In contrast to quick auto stop mode, this mode must be set before operation.

1. Set stop time

- ① Press the **TIMER** key from the initial settings screen.
- ② Mode used in the previous session will be shown in the center display. Press the **TIMER** key again and center display will begin flashing. Use **TIMER** key to select **ASTP**, signifying auto stop operation, then press the **ENTER** key.
Top display will show **50**, indicating that temperature can be set. Current temperature setting flashes in center display. **AUTO STOP** lamp also flashes.
- ③ Set temperature using **▼▲** keys.
- ④ Press the **ENTER** key again.
Top display will show **610**, indicating that timer can be set. Current timer setting will flash in center display.
- ⑤ Set timer using the **▼▲** keys.

Timer function:

Maximum setting for timer is "999 hours and 50 minutes".

The time can be set in increments of one minute, under 99 hours and 59 minutes.

Setting increments are 10 minutes, after 100 hours.

When the **▼▲** keys are held down, values advance perpetually. Press repeatedly for incremental adjustment.

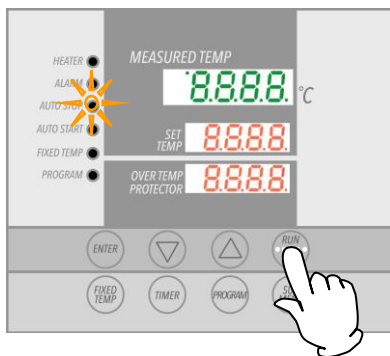

2. Start auto stop operation

Press the **RUN/STOP** key for about one second after setting timer.

AUTO STOP and **HEATER** lamp illuminate, indicating auto stop operation mode has started.

Timer begins counting down when chamber temperature reaches objective temperature.

4. OPERATION PROCEDURES

Auto Stop Mode

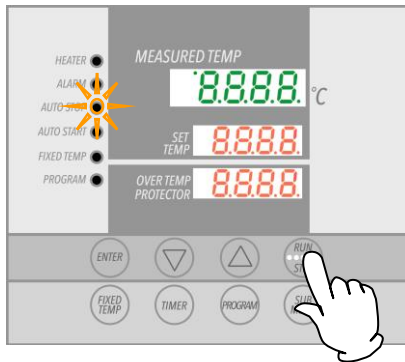

To stop/terminate auto stop operation manually

Operation stops automatically when timer reaches 0.00. An accompanying alarm sounds for approximately five seconds after operation terminates.

Center display shows `End`, indicating end of operation, with AUTO STOP lamps illuminated. Press the `RUN/STOP` key at any time during operation or after operation ends, to terminate auto stop operation mode. Displays will return to initial settings screen.

Editing or confirming settings

Changing temperature setting or timer setting during operation can be done by pressing the `TIMER` key. Use the `▼▲` keys to change the setting values. Press the `ENTER` key when changes have been entered as desired.

Press the `▼` key at any time thereafter to see temperature setting, operation mode and remaining time in the center display.

Note: Remaining time may be seen `1.30` (center display) with decimal point constant as an indicator that unit is in wait status while temperature rises or falls toward an objective temperature. When decimal point begins flashing, timer is counting down.

4. OPERATION PROCEDURES

Auto Start Mode

Auto start operation procedure

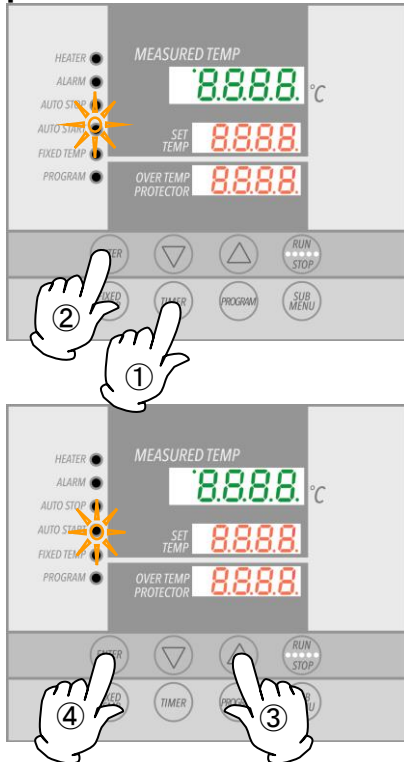

This mode is used to specify an automatic start time for constant temperature operation.

1. Set start time

- ① Press the **TIMER** key from the initial settings screen.
- ② Previous operation mode is displayed in center display. Press the **TIMER** key again and center display begins flashing. Use **TIMER** key to select **ASTr**, signifying auto start mode, then press the **ENTER** key.

Top display will show **50**, indicating temperature can now be set. Current temperature setting flashes in the center display. **AUTO START** lamp also flashes.

- ③ Set temperature using the **▼▲** keys.
- ④ Press the **ENTER** key again. Top display shows **tin**, indicating the timer can be set. Current timer setting will flash in the center display.
- ⑤ Set timer using the **▼▲** keys.

Timer function:

Maximum timer setting is "999 hours and 50 minutes".

The time can be set in increments of one minute, under 99 hours and 59 minutes.

Setting increments are 10 minutes, after 100 hours.

When **▼▲** keys are held down, values advance perpetually. Press repeatedly for incremental adjustment.

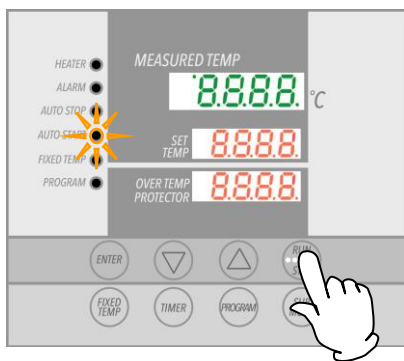

2. Initialize auto start operation

Press the **RUN/STOP** key for about one second after setting timer.

Auto start operation mode begins when timer reaches 0.00 and **AUTO START** lamp illuminates.

4. OPERATION PROCEDURES

Auto Start Mode

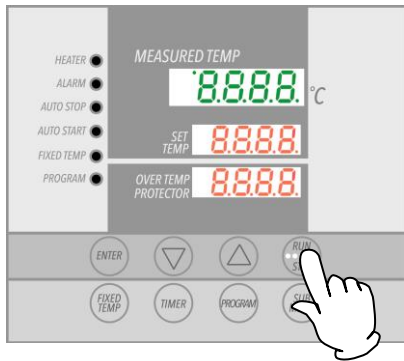

To terminate auto start operation

Operation begins automatically when timer reaches 0.00; but must be stopped manually. Auto start mode can be cancelled any time before or during operation by pressing the **RUN/STOP** key for about one second. Displays revert to initial settings screen.

Editing or confirming settings

Changing temperature settings or timer settings before an operation begins may be done by pressing the **TIMER** key. Use the **▼▲** keys to change setting values. Press the **ENTER** key when changes have been entered as desired.

These values cannot be modified once operation begins. This can only be done by pressing the **RUN/STOP** key to terminate operation and setting the values over again.

NOTE: Press the **▼** key at any time after settings are made to see temperature setting, operation mode and remaining time until start, in the center display.

4. OPERATION PROCEDURES

Programmed Operation

Programmed operation

This operation is used to run a combination of temperatures, times and modes as one operation.

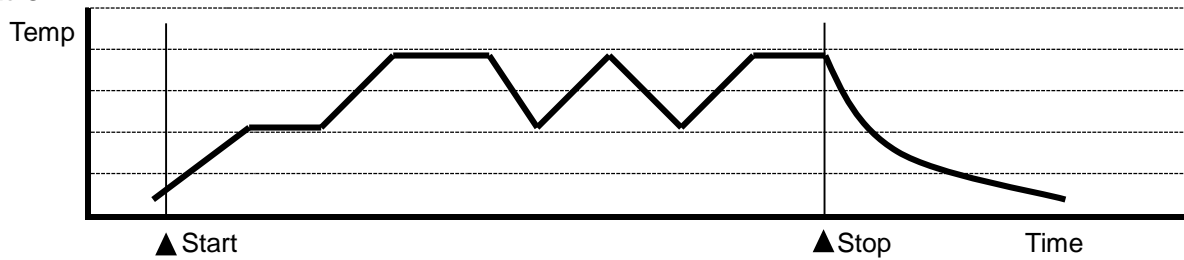

Program types

A maximum of six program pattern types can be entered (middle column).

PrG1	—	1 program pattern using up to 30 steps.
PrG2	PAt1	2 program patterns using up to 15 steps.
	PAt2	
PrG3	PAt1	3 program patterns using up to 10 steps.
	PAt2	
	PAt3	

Before program entry

Enter program patterns before attempting to run a programmed operation.

- ① Confirm the number of steps in a program composition, and its temperatures/times before entering. Using the program planning worksheet on pages 32 and 33 is recommended.
- ② Determine temperature rise/fall capability of unit. Times must be set to accommodate these capabilities.
For example, if unit is capable of increasing or decreasing temperature by 50°C in 15 minutes, approximately 30 minutes will be needed to increase or decrease temperature by 100°C from a given temperature.
- ③ Confirm that the program has a sufficient number of patterns free to allow for the number of steps to be created.
Steps using the repeat function mentioned below, however, are not counted.

Useful function

The repeat function is a convenient feature that can be used, when a series of steps, identical to ones already created, are needed to fill the remainder or remaining part of a program pattern. See "Pattern Repeat Function" (P.31)

4. OPERATION PROCEDURES

Building Programs

Temperature fall/rise curve for DKN-C models

Temperature rise and fall curves for DKN-C models are shown below in 50°C increments.

Numeric values signify time needed (in minutes) for temperature to rise or fall for every 50°C. (example: DKN-C model 602 needs approximately 15 to increase from 100°C to 150°C) Temperature stabilization time is an added factor and not included in the table below. Be sure to conduct a test run before finalizing program pattern times.

Conditions: room temperature 23°C, no load (unit: minute)

	DKN302C		DKN402C/412C		DKN602C/612C		DKN812C		DKN912C	
	Rise	Fall	Rise	Fall	Rise	Fall	Rise	Fall	Rise	Fall
210°C	5	-	5	-	5	-	5	-	5	-
200°C	15	5	20	5	20	5	15	5	25	5
150°C	10	15	15	20	15	20	10	25	20	30
100°C	10	20	15	30	15	30	10	40	20	60
50°C	5	45	5	60	5	75	5	120	5	180

Building Programs

The program pattern below will be used as an example for building programs

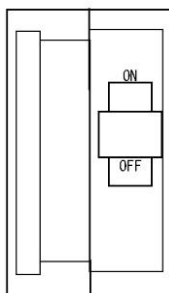
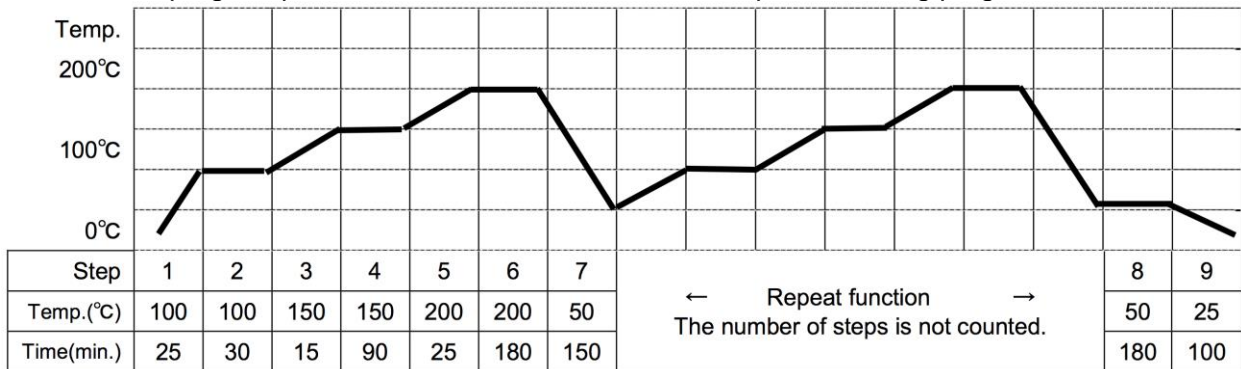

1. Turn on main circuit breaker (MCB ON "I")

Initial values will be shown for about 4 seconds after power-on, then displays will switch to the initial settings screen, showing current chamber temperature (top), operation mode character (center) and overheat prevention setting (bottom).

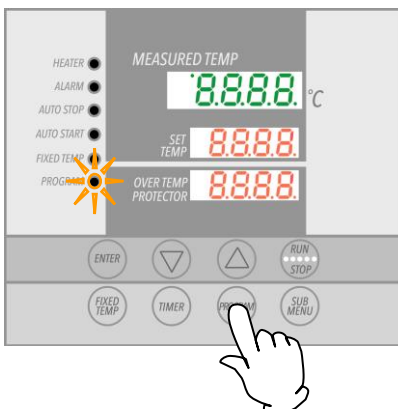

2. Select program mode/program pattern

Press the **PROGRAM** key once.

The top display will show previously used program.

Pressing the **PROGRAM** key again will cause program mode to begin flashing.

Pressing the **PROGRAM** key repeatedly thereafter will toggle between the 3 available program modes (while flashing).

4. OPERATION PROCEDURES

Building Programs

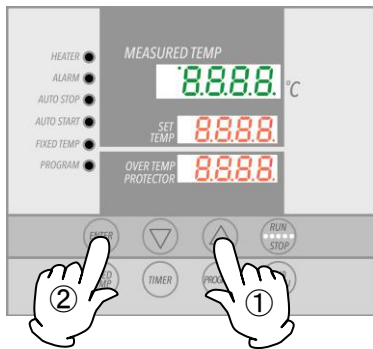

① Select mode and press the **ENTER** key.

- When PrG1 **PrG1** is selected, the top display will show **End**.
- When PrG2 **PrG2** is selected, the top display will show **PAT**, signifying program "pattern". For PrG2 pattern, select either "1" or "2" (signifying the 2 available patterns) using the **▲▼** keys. Press the **ENTER** key again. The top display will show "End".
- When PrG3 is selected, the top display will show "PAT1". For PrG3 **PrG3** patterns, select "1", "2" or "3" (3 available patterns) using the **▲▼** keys. Press the **ENTER** key again. Top display will show "End".

PrG1, PrG2 or PrG3 can be selected for the program example above, since only 8 steps are used.

The following illustrates how to enter a program, using PrG3.

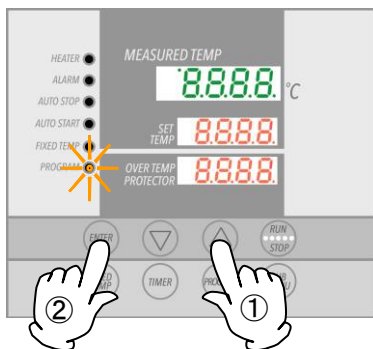

4. Enter program

- ① Select PrG3 according to step 2, above.
- ② Enter the number of steps, temperature and time for each step (use the program planning worksheet on pages 28 & 29).
- ③ Press the **ENTER** key. Pat1 will show, flashing in top display. ("End" is shown if PrG1 is selected. In this case, go to ⑥)
- ④ Select an unused pattern from among Pat1, Pat2 and Pat3 using the **▲▼** keys.
- ⑤ Press the **ENTER** key. "End" will be shown and the step number will be shown flashing.
 - ❖ "End" indicates the total step numbers to be used. In the example above, "8" would be entered here.
- ⑥ Enter the total number of steps (8 in the example above) to be used, using the **▲▼** keys
- ⑦ Press the **ENTER** key. **50.1**, indicating temperature for step 1 can now be set, will show in the top display. Current temperature setting will also be displayed flashing in the center display.
- ⑧ Set the temperature for step 1 using the **▲▼** keys.

4. OPERATION PROCEDURES

Building Programs

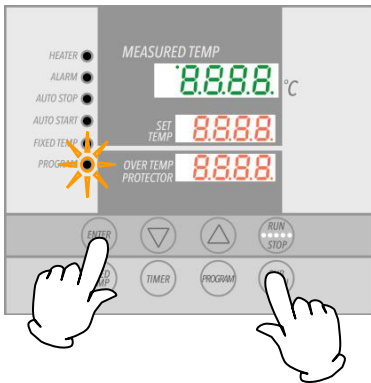

- ⑨ Press the **ENTER** key. `E_1`, indicating timer setting for step 1, will be shown in the top display. Current timer setting will also be shown flashing in the center display.
 - ❖ Before setting the timer, be sure to confirm temperature unit rise/fall capability.
 - ❖ For example, about 60 minutes is needed for a $\pm 190^{\circ}\text{C}$ increase from room temperature (20°C) to 210°C , on the DKN602C model, which is approximately 1 minute for every 3°C increase. Accordingly, it would take approximately 15 minutes to reach 50°C at the same rate. This does not include temperature stabilization time.
 - ❖ Maximum timer setting for each step is 999 hours and 50 minutes.
- ⑩ When timer is set, press the **ENTER** key. "Sv_2", indicating temperature for step 2 can now be set, will be shown in top display. Enter temperature and time using the same procedure, described thus far, for all steps (use the program planning worksheet on pages 32 & 33).
- ⑪ When the repeat function becomes necessary, press the **SUBMENU** key after setting timer (step 7 in the above example) in the step where repeat operation is to be used. This brings up repeat function setting mode.
 - ❖ Follow Pattern Repeat Function (P.31) for program repeat function entry procedure.
- ⑫ Screen returns to the initial settings screen, after setting temperature and timer in the final step.

Verification run:

When possible, confirm temperatures and times in a newly entered program by running program with unit unloaded once, before using program on actual test samples.

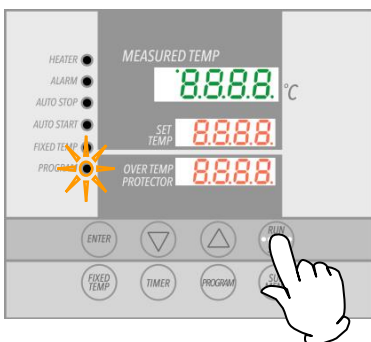

5. Run program

Press the **START/STOP** key for about one second. Program will begin running.

PROGRAM lamp illuminates and the top display will show `E_1`, signifying that step 1 is currently under way.

- ❖ Use the **▼** to monitor temperature and time (top display) remaining in a currently running step.

4. OPERATION PROCEDURES

Building Programs

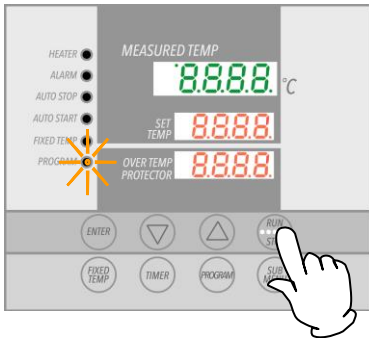

6. End programmed operation

An alert will sound when program ends.

Top display will show "END", indicating that program has finished.

Press the **START/STOP** key to return to initial setting screen.

Timer function:

Maximum setting for timer is 999 hours and 50 minutes.

Timer can be set in increments of one minute, under 99 hours and 59 minutes.

Setting increments are 10 minutes after 100 hours.

When the **▼▲** keys are held down, values will advance rapidly. Press repeatedly for incremental adjustment.

Editing or confirming settings

Press the **FIXED TEMP** key to edit a program, confirm setting values or return to a previous step. Display will return to editing and confirmation screen.

For each time **FIXED TEMP** key is pressed, screen will go back one step.

Note: Editing and confirmation must be done on program setting screen.

Wait status in programmed operation

Succeeding steps will not start if chamber temperature fails to reach, or if it exceeds objective temperature. DKN-C series units, however, are programmed to begin succeeding steps when chamber temperature is within $\pm 3^{\circ}\text{C}$ of objective temperature.

4. OPERATION PROCEDURES

Pattern Repeat Function

Setting program repeat function

This section illustrates how to use the repeat function (repeat a program pattern) in a programmed operation.

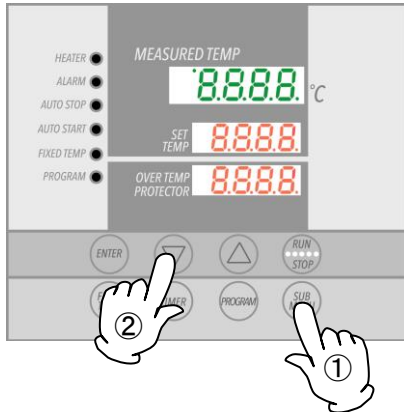

Set program repeat

The following illustration continues from ④ of Step 4, "Enter program," above.

This procedure sets the step number to be repeated, "PS_x", and number of times to repeat, "Pc_x" (x = step number)

- ① After setting the timer, press the the **SUBMENU** key (Step 7 in the preceding example). This brings up the repeat function setting mode.
- ② Top display will show "PS_x", indicating the step to be repeated in the program pattern. **PS_7** would be shown in the example above, since repeat function is used at the seventh step. Step numbers 1 to 7 can be entered into the center display. Enter the number (1 in the example) using the **▲▼** keys.
- ③ Press the **SUBMENU** key. Top will show "Pc_x", indicating the number of times to repeat. Enter this value (2 in the example) into the center display with the **▲▼** keys.
- ④ Screen proceeds to the next step when the **SUBMENU** key is pressed again. Sv_8 would be displayed next (in the case of example above).

Editing and confirming settings

Editing settings is not possible while in repeat setting mode.

To edit or confirm the settings, complete current step entry, then press the FIXED TEMP key, when temperature setting screen for the next step appears. Display will return to previous screen, where editing can be done.

Note: Editing and confirmation must be done in the program setting screen.

Contact original dealer of purchase, if further questions arise concerning operation procedures.

4. OPERATION PROCEDURES

Program Planning Worksheet

Do not write in this manual. Please make copies.

Input into:	PrG1 PrG2 PrG3 PA1 PA2 PA3	No.	
Project Name		Date	
		Programmer	

Input Value

	Temperature (°C)	Time (min.)	Repeat Function (Point of return : number of times)
Step 1		:	:
Step 2		:	:
Step 3		:	:
Step 4		:	:
Step 5		:	:
Step 6		:	:
Step 7		:	:
Step 8		:	:
Step 9		:	:
Step 10		:	:
Step 11		:	:
Step 12		:	:
Step 13		:	:
Step 14		:	:
Step 15		:	:
Step 16		:	:
Step 17		:	:
Step 18		:	:
Step 19		:	:
Step 20		:	:
Step 21		:	:
Step 22		:	:
Step 23		:	:
Step 24		:	:
Step 25		:	:
Step 26		:	:
Step 27		:	:
Step 28		:	:
Step 29		:	:
Step 30		:	:

4. OPERATION PROCEDURES

Other Functions: Calibration Offset

Using calibration offset

Calibration offset is function which can correct for any differences discovered between actual chamber temperature (taken manually) and the temperature displayed on the control panel (taken by built-in sensor). Offset function can correct to either the positive or negative side of the entire unit temperature range. Offset function can be set or cancelled with the **SUBMENU** key.

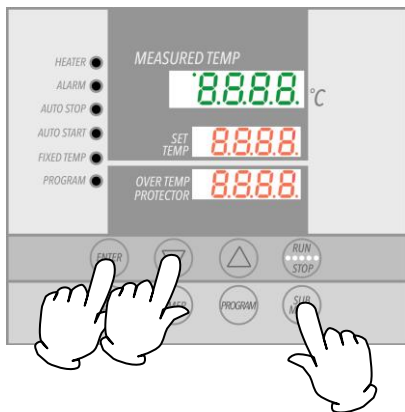
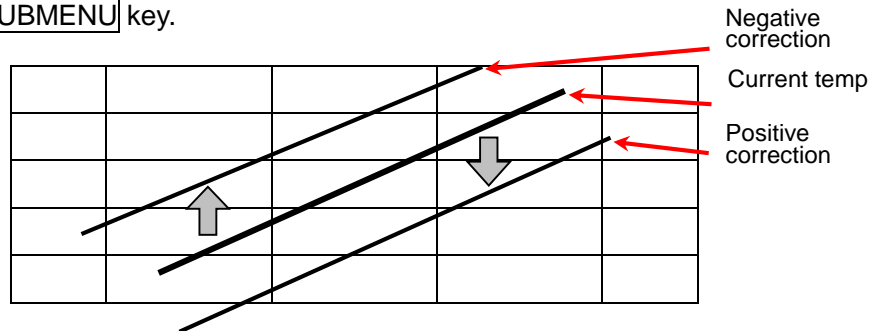

- ① Run unit in constant temperature mode. When temperature stabilizes, gauge chamber temperature with a thermograph.
- ② Confirm whether there is difference between display temperature (shown in top display) and chamber temperature, as recorded by the thermograph. If a difference in temperature values is confirmed, follow the procedure below.
- ③ Press the **SUBMENU** key. Select **CAL**, indicating calibration offset, using the **▲▼** keys and press the **ENTER** key.
- ④ Enter a value that brings temperature display (top display) and chamber temperature into agreement, using the **▲▼** keys and press the **ENTER** key up to +99 or -99 in either direction of 0.

Setting calibration offset to the negative side of 0 **increases** actual temperature by the negative value entered (i.e. entering a value of -3 increases actual temperature by 3°C)

Setting calibration offset to the positive side of 0 **decreases** actual temperature by positive value entered (i.e entering +3 decreases actual temperature by 3°C)

- Entering excessive compensation values may cause a precariously large discrepancy between actual temperature and temperature reading. Contact original dealer of purchase if entering large compensation values is required.
- In addition to the calibration offset function, DKN-C series units have a two-point offset function built in, which has some compensating effects in low and high temperature zones. These offsets have already been entered at the factory.
- Contact original dealer of purchase, if further questions arise concerning operation procedures.

4. OPERATION PROCEDURES

Other Functions: Keypad Lock

Using keypad lock

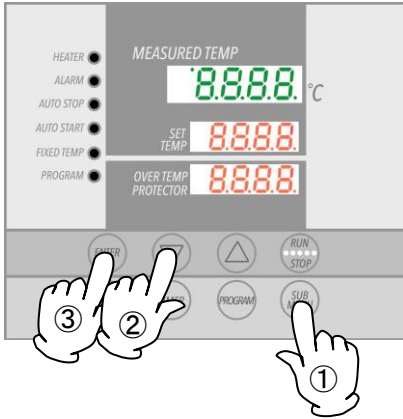

This function locks all keys except the SUBMENU and START/STOP keys, so that settings cannot be unintentionally changed.

Lock is set or cancelled with the **SUBMENU** key.

- ① Press the **SUBMENU** key. Select **Lock**, indicating key lock function, using the **▲▼**, and press the **ENTER** key.
- ② Center display will read "oFF". The the keys are locked when "On" is selected using the **▲** key.
- ③ To cancel the lock, press the **SUBMENU** key again. Select **Lock** using the **▲▼** keys and press the **ENTER** key. Select "oFF" with the **▼** key, then press the **ENTER** key to cancel the function.

- With the keypad lock function ON, all keys become unresponsive except the **START/STOP** and **SUBMENU** keys.

5. HANDLING PRECAUTIONS

Warning

1. Hazardous substances



Never process explosive or flammable items. Fire or explosion causing serious injury or death may result. See "List of Hazardous Materials" on P.52.

2. Sample moisture precaution



When processing excessively wet samples, remove as much of the moisture as possible beforehand to prevent condensation from collecting on, and excessive humidity from having an effect on internal electrical components, possibly causing damage, short circuit or electric shock.

3. DO NOT operate equipment when abnormalities are detected



If unit begins emitting smoke or abnormal odors for reasons unknown, turn off main circuit breaker (MCB) immediately, disconnect power cable from power supply, and contact original dealer of purchase. Continuing to operate without addressing abnormalities may cause fire or electric shock, resulting in serious injury or death. Never attempt to disassemble or repair unit. Repairs should be always be performed by a certified technician.

Caution

1. DO NOT climb on equipment



Do not attempt to climb onto unit or substitute it for a proper stepladder. Units are not designed to support bodily weight and damage may result. In addition, unit may become unstable and tip over or fall resulting in equipment damage, serious injury or death.

2. DO NOT operate equipment during thunderstorms



In the event of a thunderstorm, turn off main circuit breaker (MCB), and disconnect power cable immediately. A direct lightning strike may cause equipment damage fire or electric shock, resulting in serious injury or death.

3. Caution: HOT



Some exterior surfaces may become HOT during operation. Exercise extreme caution not to contact these surfaces. Burn injury may result. Likewise, avoid contact with exhaust ports and surrounding areas, as these may become extremely HOT.

4. Caution when opening and closing door



Do not attempt to open oven door until chamber has fallen below 50°C, or unless unit is operating below 50°C. Interior surfaces will still be HOT at this temperature. Avoid direct contact with interior surfaces to prevent burn injury.

5. Do not operate unit with door open



Operating DKN-C units with door open will render thermostat unable to maintain proper temperature control, and may cause damage or premature wear to heater element due to overloading. Always close door before operation. Do not leave door open with test samples left inside in attempt to cool samples rapidly. Hot air dispelling from chamber may cause burn injuries and may damage control panel or other electronic components.

5. HANDLING PRECAUTIONS



6. DO NOT process corrosive substances



Potent acids may corrode unit interior, despite stainless steel construction. Solvents, such as alkalis, oils, halogens, etc, may also compromise silicon rubber door seal. Do not process corrosive substances or items containing corrosive substances.

7. ALWAYS run equipment within specified temperature range



Operational temperature range for DKN-C series units is 0~260°C (DKN912C is 0~210°C). Never attempt to operate unit outside of the above specified temperature range. Doing so may cause equipment malfunction or damage.

5. HANDLING PRECAUTIONS



Caution

8. Sample distribution



Supplied chamber rack capacity is 15kg each. Place items as evenly and as far apart as possible and do not exceed maximum load rating. Bunching multiple together in order to get more onto a single rack may compromise temperature accuracy. Distribute samples evenly and leave approximately 30% of rack space open for best results.

9. DO NOT place items on bottom surface of chamber



Operating unit with test samples placed directly on bottom surface of chamber may cause unit to perform poorly. Likewise, chamber temperature may become excessive, causing malfunction or damage. Always use the included racks, supported on the standard rack pegs, and avoid placing any items on bottom surface. DO NOT remove screws from bottom-most rack.

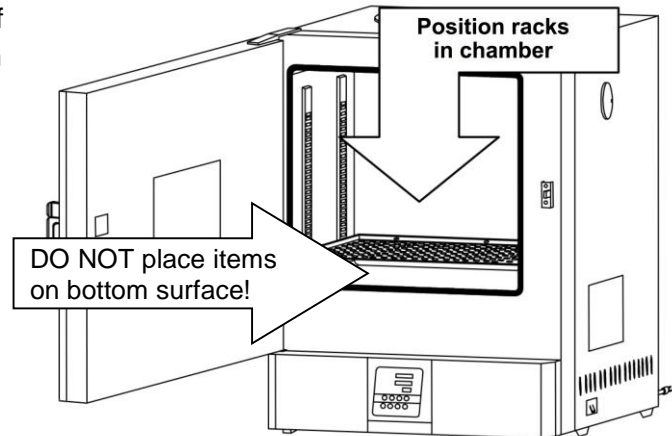

10. Power loss recovery



In the event of a power loss, unit automatically reverts to status just before power loss and begin operation once again from that point.

11. Stacking



When stacking units is required, use optional dedicated stacking hardware (maximum 2 units). Do not attempt to stack any unit directly on top of another.

12. Post-installation measures



In the event of earthquakes or other unforeseen incidents, unit may tip over or fall. Implement appropriate safety measures to stabilize unit following installation.

6. MAINTENANCE PROCEDURES

Inspection and Maintenance

Warning



- Be sure that main circuit breaker (MCB) is OFF before daily inspection and maintenance of DKN-C series units.
- Perform inspections and maintenance when inside of chamber is at room temperature.
- Never attempt to disassemble unit..

Caution

- Clean unit using soft damp cloth.
- Never use benzene, paint thinner, scouring powder, scrubbing brush or other abrasives and solvents to clean unit. Superficial damage and/or discoloration, as well as deformity to some components may result.

7. EXTENDED STORAGE AND DISPOSAL

Extended Storage / Unit Disposal

 Warning	 Caution
<p>If unit will be out of service for an extended period, turn off main circuit breaker (MCB) and disconnect power cable from facility outlet or terminal.</p>	<p>Unit disposal.</p> <ul style="list-style-type: none"> ● Remove door and hinges to prevent it from closing. ● Do not leave unit where it may be unattended, or in a location where children may have access. ● Dispose of this unit in accordance with local laws and regulations.

Disposal Considerations

Dispose of or recycle this unit in a responsible and environmentally friendly manner.

Yamato Scientific Co., Ltd. strongly recommends disassembling unit, as far as is possible, in order to separate parts and recycle them in contribution to preserving the global environment.

Major components and materials, comprising DKN-C series units are listed in the table below:

Component Name	Material
Exterior Parts	
Outer covering	Steel plate SPCC (powder coating)
Furnace	Stainless steel
Heat insulation material	Glass wool
Door packing	Foam silicon rubber
Plates	PET resin film
Electrical Parts	
Heater	SUS pipe heater
Motor	Steel plate, Copper wire, resin coated wire and other
Circuit boards	Board, Condenser, Transformer and other
Power cord, Wiring	Synthetic rubber or resin coated wiring materials

8. ERROR CODES







Reading Error Codes

DKN-C series units have a self-diagnostic function built into the CPU board and a separate safety device, independent of the CPU board.

The table below shows possible causes and measures to take when safety device is triggered.

Error Codes

When an operational error or malfunction occurs, the alarm lamp on the control panel illuminates, an error code is displayed, and an alarm sounds. When an error occurs, confirm the error code and terminate operation immediately. Note that a temperature gauging error will be indicated by ALARM lamp illuminating and accompanied by dashes in the display. No error code will be displayed and no alarm will sound.

Safety device	Symptom	Possible causes and measures
Sensor error detected	Alarm lamp on  in display	<ul style="list-style-type: none"> ● Temperature sensor interrupted, disconnected or other malfunction <p>Contact original dealer of purchase</p>
Short circuit detected	Alarm lamp on  in display	<ul style="list-style-type: none"> ● Short circuit in SSR (solid state relay) <p>Contact original dealer of purchase</p>
Heater interruption detected	Alarm lamp on  in display	<ul style="list-style-type: none"> ● Heater interrupted or disconnected ● Current detection element interrupted, disconnected or other malfunction <p>Contact original dealer of purchase</p>
Memory error	Alarm lamp on  in display	<ul style="list-style-type: none"> ● Memory setting error <p>Contact original dealer of purchase</p>
Internal communication error	Alarm lamp on  in display	<ul style="list-style-type: none"> ● Internal communication error, temperature input circuit error <p>Contact original dealer of purchase</p>
Overheat	Alarm lamp on  in display	<ul style="list-style-type: none"> ● Overheat prevention unit activated ● Overheat prevention unit interrupted disconnected or other malfunction <p>Check the temperature setting. If the unit does not reset, contact service department.</p>
Temperature gauging error	— — — — in display	<p>Gauged temperature is out of display range Contact original dealer of purchase</p>

8. TROUBLESHOOTING

Troubleshooting Guide

Symptom	Check
Unit does not turn on/nothing is displayed in control panel displays when main circuit breaker (MCB) is turned "ON".	<ul style="list-style-type: none"> ● Whether power cable is connected securely to power terminal or outlet. ● Whether a power outage is in progress.
Temperature in chamber does not rise.	<ul style="list-style-type: none"> ● Whether temperature setting is below chamber temperature. ● Whether power supply voltage has dropped. ● Whether external temperature is within operable temperature range. (operable external temperature range is 5°C~35°C) ● Whether chamber is overloaded (too many samples).
Temperature fluctuates during operation.	<ul style="list-style-type: none"> ● Whether temperature setting is appropriate. ● Whether power supply voltage has dropped. ● Whether there are large fluctuations in external temperature. ● Whether chamber is overloaded (too many test samples).
Temperature reading differs from manually gauged temperature.	<ul style="list-style-type: none"> ● Whether calibration offset is set to a value other than "0". If this is the case, set it back to "0". See "Calibration Offset" (P.33) and confirm calibration offset setting.
Overheat prevention device activates.	

- ◆ If problem persists, turn off power immediately, disconnect power cable from outlet or terminal and contact original dealer of purchase for assistance.

9. SERVICE & REPAIR

Requests for Repair

When a problem occurs, terminate operation immediately, turn off main circuit breaker (MCB) and disconnect power cable and contact original dealer of purchase for assistance.

The following information is required for all repairs.

- Model name
- Serial Number
- Date (year/month/day) of purchase
- Description of problem in as much detail as possible

} Refer to serial no. and rating
label on unit.
See P.10~12 for label location.

Guaranteed Supply Period for Repair Parts

Guaranteed maximum supply period for repair parts is 7 (seven) years from date of discontinuation for DKN-C series ovens. "Repair parts" is defined as components which, when installed, allow for continued unit operation.

10. SPECIFICATIONS

	DKN302C	DKN402C/412C	DKN602C/612C	DKN812C	DKN912C
System	Forced circulation				
Temperature range *1	Room Temp + 10°C ~ 260°C			R.T. + 10 ~ 210°C	
Temperature control accuracy *1	±1°C (Chamber center, 210°C, Damper: fully closed)				
Temperature distribution accuracy *1	±2.5°C (Set temp.: 210°C, Damper: full opened) ±2.8°C (Set temp.: 260°C, Damper: full closed)			±2.5°C (Set temp.: 210°C, Damper: full closed)	
Temperature rise time *1	(Room temp. to max temp) Approx. 80min.			Approx. 60min.	
Temperature fall time	(210°C~50°C) Approx. 150min		Approx. 160min	Approx. 220min	
Heater	Stainless SUS tube heater				
	0.8kW	1.2kW	1.5kW	1.5kW x 2	1.8kW x 2
Controller	Model VS4				
Fan motor	10W capacitor (1)			30W (1)	10W (2)
Cable port	Inner dia. 30mm x 2 (top panel)			Inner dia. 30mm x 2 (rear panel)	
Observation window	180x180mm tempered glass	250x280 tempered glass		-	
Temperature control system	PID control via microcomputer				
Setting system	Digital setting by menu key and up/down keys				
Display system	Temperature reading display: green 4-digit digital LED				
	Temperature setting display: orange 4-digit digital LED				
Timer	1min~99hrs, 59min or 100hrs~999.5hrs (wait function included), res. 1 or 10min				
Operation modes	Fixed temperature, Quick Auto Stop, Auto Stop, Auto Start, Program				
Program operation	3 patterns, 30 steps in program mode, repeat function included				
Sensor	K-thermocouple				
Additional functions	Lock function, Auto recovering after power failure, Calibration offset				
Self-diagnostic functions	Failure of Sensor, heater, SSR, memory, internal communication, temperature inputting circuit, automatic overheating prevention device, overheating prevention device, measurement temperature				
Safety devices	Main Circuit breaker, Overheating prevention device				
External dimensions (W × D × H mm) *1	410x451x670	560x601x820	710x651x870	710×651×1608	1180 x 651 x 1616
Internal dimensions (W × D × H mm)	300x300x300	450x450x450	600x500x500	600x500x1000	1070 x 500 x 1000
Capacity	Approx. 27L	Approx. 90L	Approx. 150L	Approx. 300L	Approx. 535L
Chamber rack load capacity	Approx.15kg / rack				
Number of tiers/rack support pitch	6 tiers / 30mm	11tiers / 30mm	12 tiers / 30mm	29 tiers / 30mm	(29 tiers / 30mm) × 2

10. SPECIFICATIONS

	DKN302C	DKN402C/412C		DKN602C/612C		DKN812C	DKN912C
Power supply V \pm 10%	115V AC	115VAC	220VAC	115VAC	220VAC	220V AC	
50/60Hz, single phase	8.5A	12.5A	6.5A	14A	7A	12.5A	15.5A
Ext. temp/humidity range	5-35°C / below 85% (to prevent internal condensation)						
Conformance standard	CE Mark						
Location requirements	Indoor use only (contamination level 2), elevation below 2,000m (EN61010-1)						
Weight	Approx. 35kg	Approx. 50kg		Approx. 65kg		Approx. 110kg	Approx. 190kg
Included items	Chamber racks (load capacity: 15kg/rack): 2					4	8
	Rack supports: 4					8	16
	Instruction manual, warranty card, [4 caster holders – DKN812C/912C only]						

*1 Performance data above based on 115V or 220V AC supplied power, 23°C \pm 5°C (room temperature), 65%RH \pm 20% humidity, and no process load.

*2 Dimensions do not include protrusions.

11. WIRING DIAGRAM

DKN302C/402C/602C

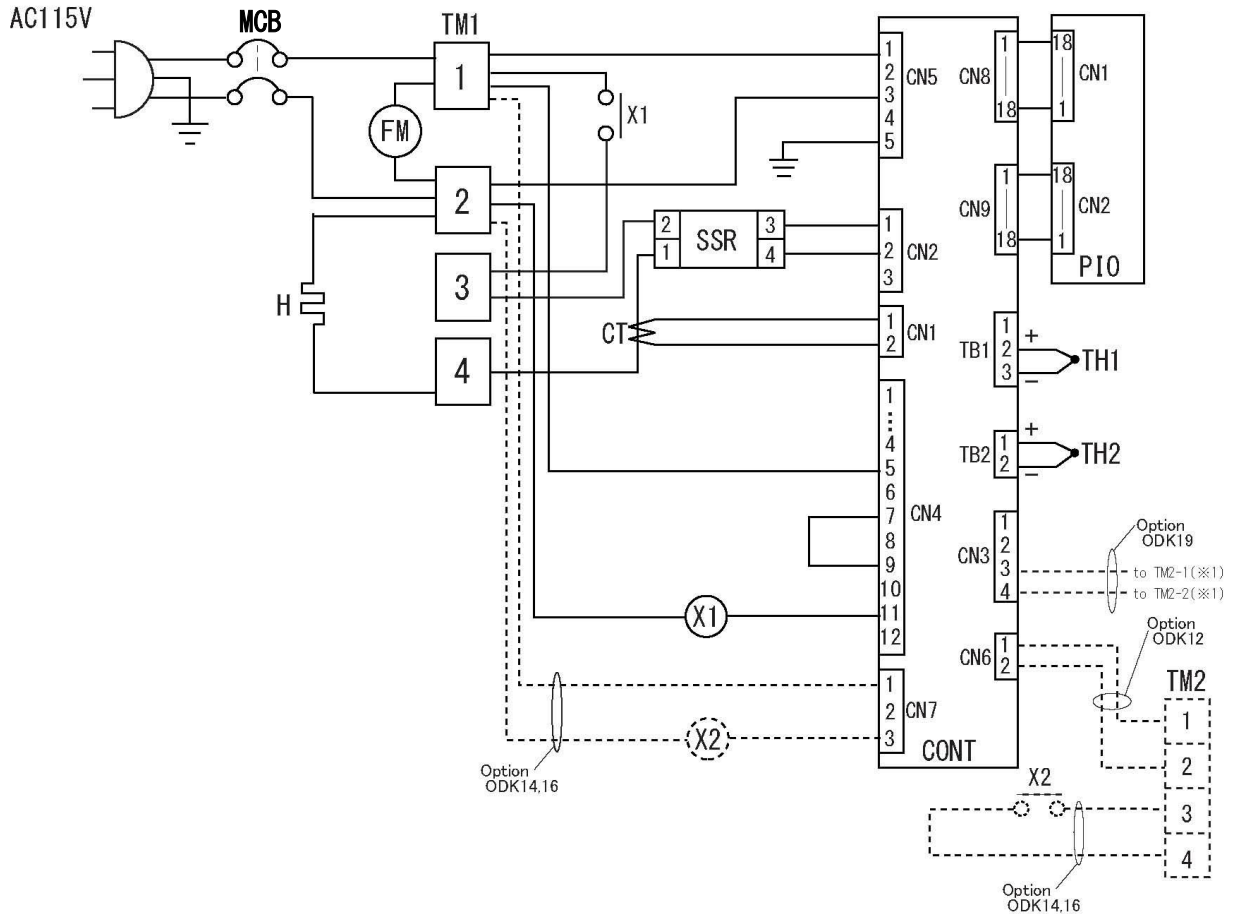

*1 Options ODK12 & ODK19 should be connected to TM2-3 & TM2-4 when used together.
 ----- indicates optional components.

Wiring Diagram Symbol Glossary

Symbol	Component	Symbol	Component
MCB	Main Circuit Breaker	CONT	Control Circuit Board
TM1	Terminal Block	PIO	Display Circuit Board
H	Heater	TH1	Temperature Sensor
X1	Main Relay	TH2	Overheat Prevention Sensor
FM	Circulation Fan Motor	CT	Current Detection Element
SSR	Solid State Relay	TM2	Option Terminal Block
X2	Option Relay		

11. WIRING DIAGRAM

DKN412C/612C

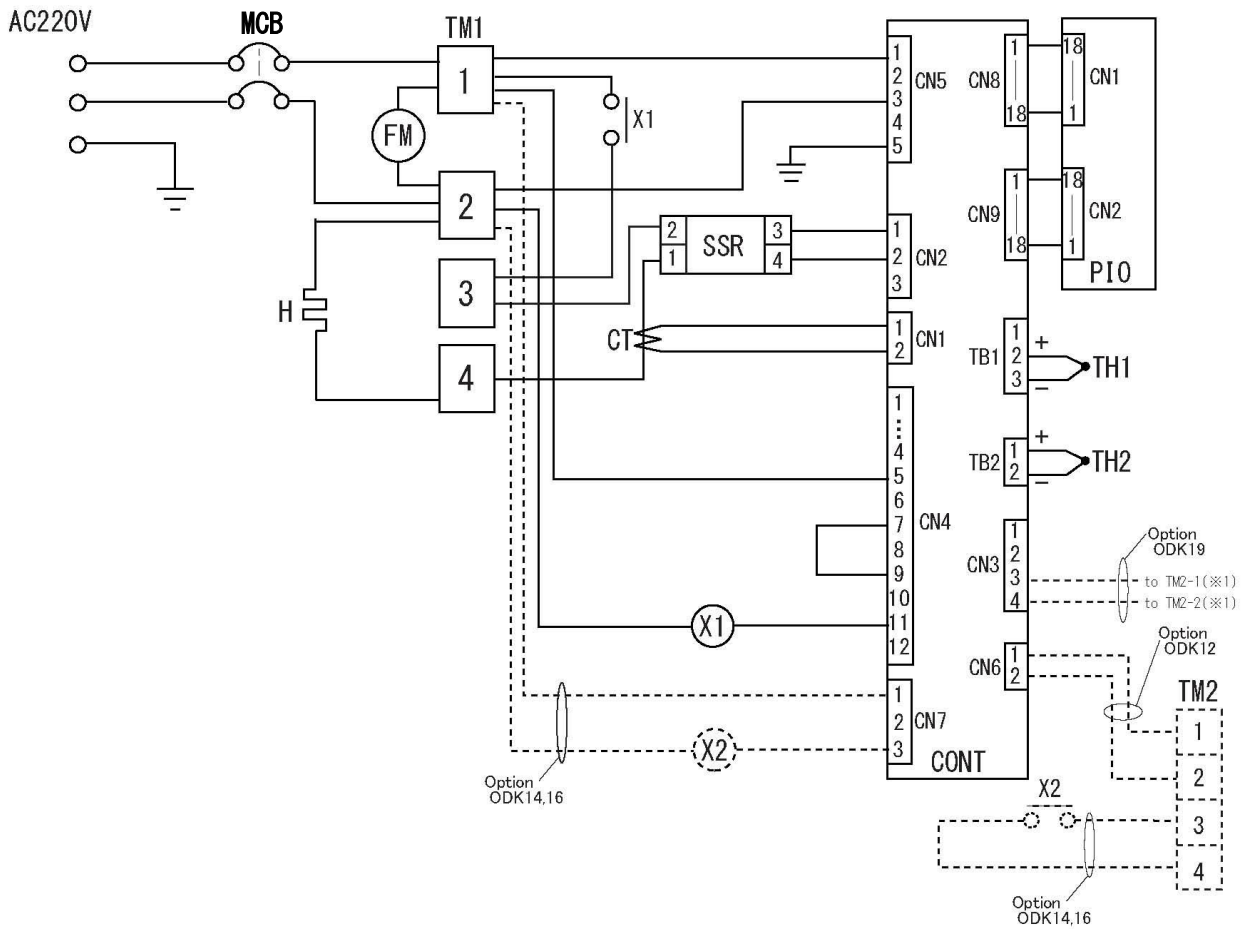

*1 Options ODK12 & ODK19 should be connected to TM2-3 & TM2-4 when used together.
 ----- indicates optional components.

Wiring Diagram Symbol Glossary

Symbol	Component	Symbol	Component
MCB	Main Circuit Breaker	CONT	Control Circuit Board
TM1	Terminal Block	PIO	Display Circuit Board
H	Heater	TH1	Temperature Sensor
X1	Main Relay	TH2	Overheat Prevention Sensor
FM	Circulation Fan Motor	CT	Current Detection Element
SSR	Solid State Relay	TM2	Option Terminal Block
X2	Option Relay		

11. WIRING DIAGRAM

DKN812C

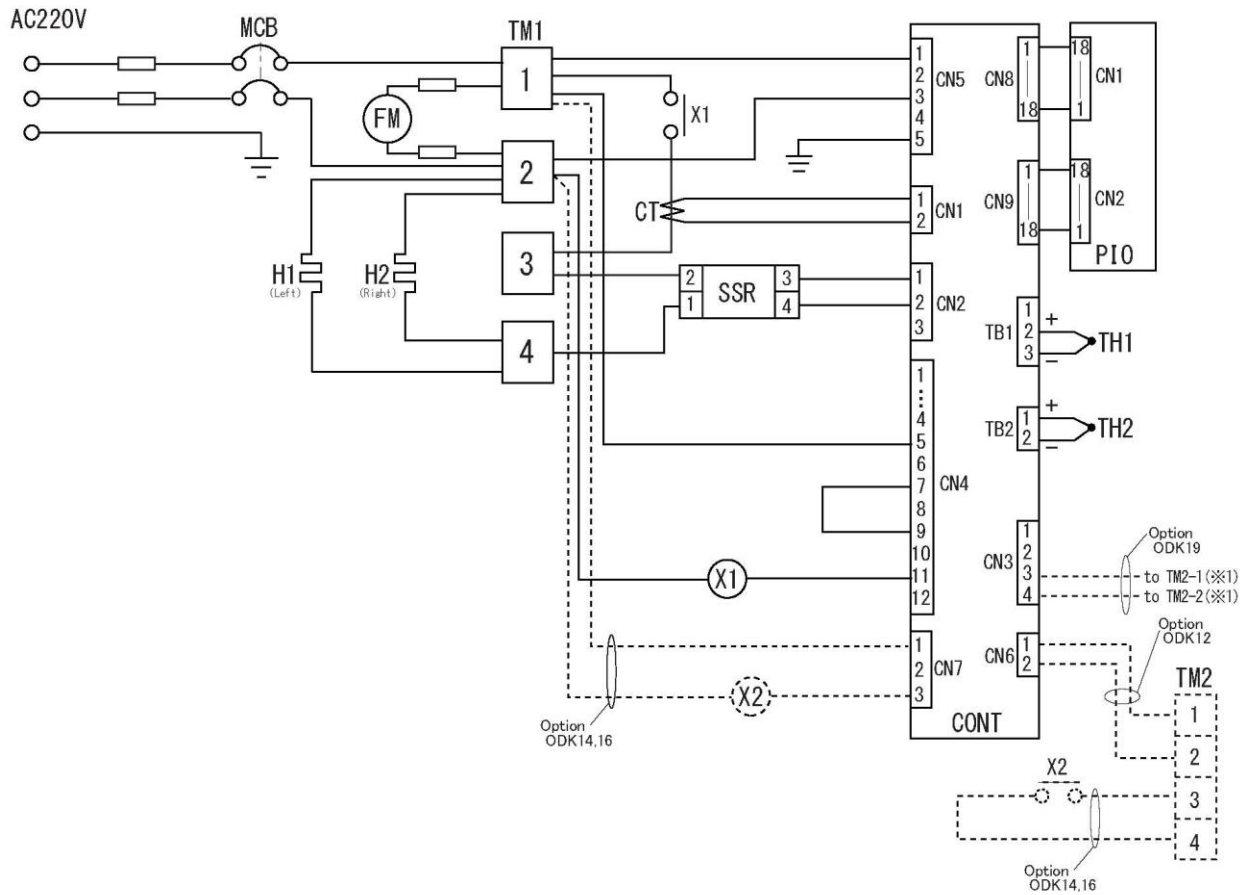

*1 Options ODK12 & ODK19 should be connected to TM2-3 & TM2-4 when used together.
 ----- indicates optional components.

Wiring Diagram Symbol Glossary

Symbol	Component	Symbol	Component
MCB	Main Circuit Breaker	CONT	Control Circuit Board
TM1	Terminal Block	PIO	Display Circuit Board
H	Heater	TH1	Temperature Sensor
X1	Main Relay	TH2	Overheat Prevention Sensor
FM	Circulation Fan Motor	CT	Current Detection Element
SSR	Solid State Relay	TM2	Option Terminal Block
X2	Option Relay		

11. WIRING DIAGRAM

DKN912C

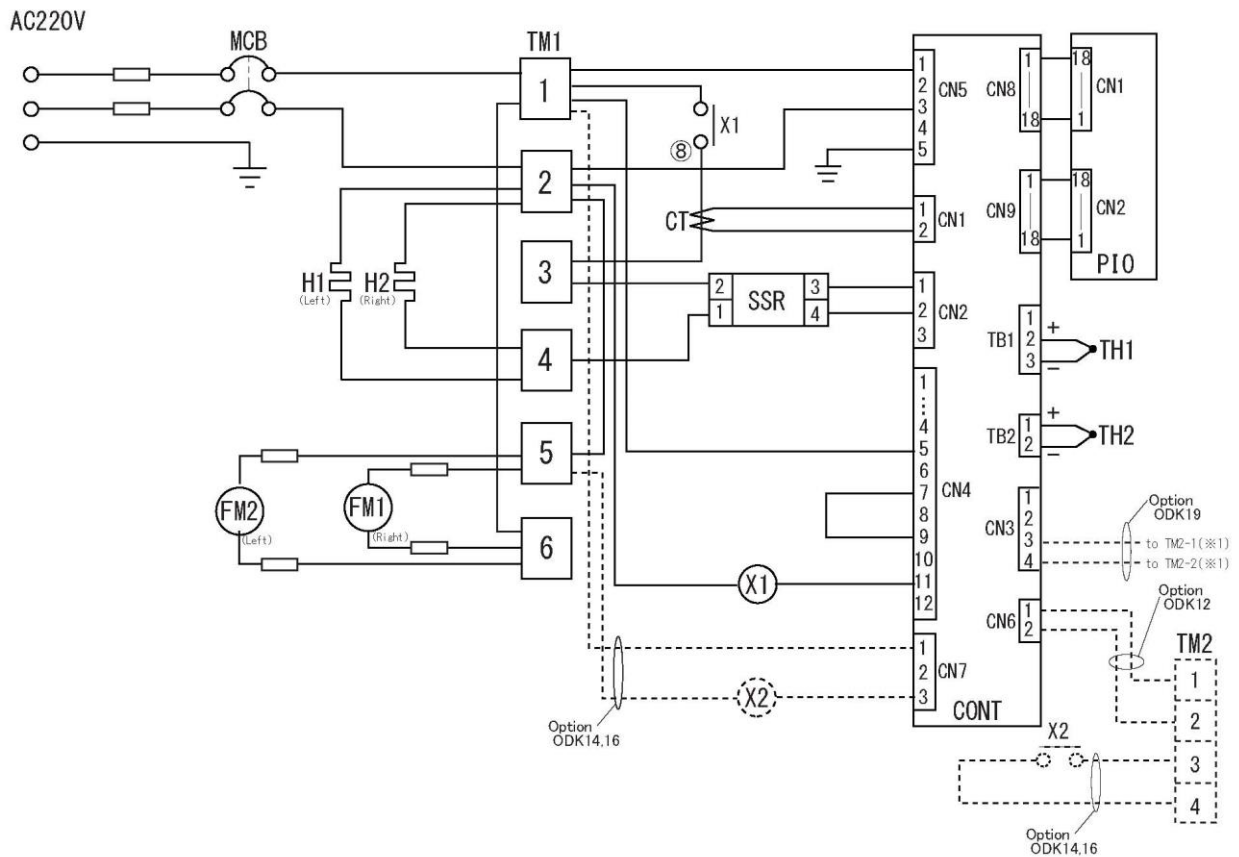

*1 Options ODK12 & ODK19 should be connected to TM2-3 & TM2-4 when used together.
 ----- indicates optional components.

Wiring Diagram Symbol Glossary

Symbol	Component	Symbol	Component
MCB	Main Circuit Breaker	CONT	Control Circuit Board
TM1	Terminal Block	PIO	Display Circuit Board
H1, 2	Heater	TH1	Temperature Sensor
X1	Main Relay	TH2	Overheat Prevention Sensor
FM1	Right Fan Motor (CW)	CT	Current Detection Element
FM2	Left Fan Motor (CCW)	X2	Option Relay
SSR	Solid State Relay	TM2	Option Terminal Block

12. REPLACEMENT PARTS LIST

All models

Symbol	Component	Standard	Manufacturer	Part No.
TH1, 2	Sensor	TN-5158 K-type	Shinko Techno	1160030049
CONT	VS4 motherboard	VS4P	Yamato Scientific	1020000055
PIO	VS3, 4 display board	VS3,4	Yamato Scientific	1020000051
	Ribbon cable	15P, 300 mm	Toho Electric	1130000008
SSR	SSR	TRS5225	Toho Electric	2160000035
CT	Current transformer	CTL-6-S-H	URD	2170010005
MCB	Circuit breaker	QOU220 20A	Schneider	LT00037613

DKN302C Only

Symbol	Component	Standard	Manufacturer	Part No.
H	Heater	SUS tube heater 800W	Yamato Scientific	LT00037614
FM	Motor	IC8422YAMC	Yamato Scientific	2140000032
X1	Relay	AHE1254 100/120V	Panasonic	2050000019
	Power cable	FJCU15A-P-3	Yamato Scientific	LT00037616
	Cable strain relief boot	SR-7W-2	Heiko	A0036

DKN402C Only

Symbol	Component	Standard	Manufacturer	Part No.
H	Heater	SUS tube heater 1.2kW	Yamato Scientific	LT00020598
FM	Motor	IC8422YAMC 10W C.C.W	Yamato Scientific	2140000032
X1	Relay	AHE1254 100/120V	Panasonic	2050000019
	Power Cable	FJCU15A-P-3	Yamato Scientific	LT00037616
	Cable strain relief boot	SR-7W-2	Heiko	A0036

DKN412C Only

Symbol	Component	Standard	Manufacturer	Part No.
H	Heater	SUS tube heater 1.2kW	Yamato Scientific	LT00037615
FM	Motor	IC8422YAMB 10W C.C.W	Yamato Scientific	LT00037619
X1	Relay	AHE1255 220V	Panasonic	2050000044
	Power cable	STO-14-3-3	Yamato Scientific	LT00037617
	Cable strain relief boot	SR-8P-2	Heiko	FM374

12. REPLACEMENT PARTS LIST

DKN602C Only

Symbol	Component	Standard	Manufacturer	Part No.
H	Heater	SUS tube heater 1.5kW	Yamato Scientific	LT00020599
FM	Motor	IC8422YAMC 10W C.C.W	Yamato Scientific	2140000032
X1	Relay	AHE1254 100/120V	Panasonic	2050000019
	Power cable	FJCU15A-P-3	Yamato Scientific	LT00037616
	Cable strain relief boot	SR-7W-2	Heiko	A0036

DKN612C Only

Symbol	Component	Standard	Manufacturer	Part No.
H	Heater	SUS tube heater 1.2kW	Yamato Scientific	LT00037629
FM	Motor	IC8422YAMB 10W C.C.W	Yamato Scientific	LT00037619
X1	Relay	AHE1255 220V	Panasonic	2050000044
	Power cable	STO-14-3-3	Yamato Scientific	LT00037617
	Cable strain relief boot	SR-8P-2	Heiko	FM374

DKN812C Only

Symbol	Component	Standard	Manufacturer	Part No.
H1, 2	Heater	SUS tube heater 1.5kW	Yamato Scientific	LT00022052
FM	Motor	IC8434YAMC 30W C.C.W	Yamato Scientific	2140000037
X1	Relay	AHE1255 220V	Panasonic	2050000044
	Power cable	STO-14-3-3	Yamato Scientific	LT00037617
	Cable strain relief boot	SR-8P-2	Heiko	FM374

DKN912C Only

Symbol	Component	Standard	Manufacturer	Part No.
H1, 2	Heater	SUS tube heater 1.5kW × 2	Yamato Scientific	LT00006028
FM1	Motor	IC8422YAMB 220V 10W	Yamato Scientific	LT00037619
FM2	Motor	IC8422YAMD 220V 10W	Yamato Scientific	LT00037620
X1	Relay	AHE1255 220V	Panasonic	2050000044
	Power Cable	STO-12-3-3	Yamato Scientific	LT00037618
	Cable strain relief boot	ST21	Yamato Scientific	LT00037621
	Rubber gasket	For GP21 ST21	Yamato Scientific	LT00037622
	Lock nut	For GMP-GL21 ST21	Yamato Scientific	LT00037623

13. HAZARDOUS SUBSTANCES LIST



Never attempt to process explosives, flammables or any items which contain explosives or flammables

Explosive Substances	①Nitroglycol, Glycerine trinitrate, Cellulose Nitrate and other explosive nitrate esters
	②Trinitrobenzen, Trinitrotoluene, Picric Acid and other explosive nitro compounds
	③Acetyl Hydroperoxide, Methyl Ethyl Ketone Peroxide, Benzoyl Peroxide and other organic peroxides
	④Metallic Azide, including Sodium Azide, etc.
Combustible Substances	①Metal "Lithium" ②Metal "Potassium" ③Metal "Natrium" ④Yellow Phosphorus
	⑤Phosphorus Sulfide ⑥Red Phosphorus⑦Phosphorus Sulfide
	⑧Celluloids, Calcium Carbide (a.k.a, Carbide)⑨Lime Phosphide⑩Magnesium Powder
	⑪Aluminum Powder ⑫Metal Powder other than Magnesium and Aluminum Powder
	⑬Sodium Dithionous Acid (a.k.a., Hydrosulphite)
Oxidizing Substances	①Potassium Chlorate, Sodium Chlorate, Ammonium Chlorate, and other chlorates
	②Potassium Perchlorate, Sodium Perchlorate, Ammonium Perchlorate, and other perchlorates
	③Potassium Peroxide, Sodium Peroxide, Barium Peroxide, and other inorganic peroxides
	④Potassium Nitrate, Sodium Nitrate, Ammonium Nitrate, and other nitrates
	⑤Sodium Chlorite and other chlorites
	⑥Calcium Hypochlorite and other hypochlorites
Flammable Substances	①Ethyl Ether, Gasoline, Acetaldehyde, Propylene Chloride, Carbon Disulfide, and other substances having ignition point of 30 or more degrees below zero.
	②n-hexane, Ethylene Oxide, Acetone, Benzene, Methyl Ethyl Ketone and other substances with ignition point between 30 degrees below zero and less than zero.
	③Methanol, Ethanol, Xylene, Pentyl n-acetate, (a.k.a.amyl n-acetate) and other substances having ignition point of between zero and less than 30 degrees.
	④Kerosene, Light Oil, Terebinth Oil, Isopenthyl Alcohol(a.k.a. Isoamyl Alcohol), Acetic Acid and other substances having ignition point of between 30 degrees and less than 65 degrees.
Combustible Gas	Hydrogen, Acetylene, Ethylene, Methane, Ethane, Propane, Butane and other gases combustible at 15°C, ambient air pressure.

Limited Liability

Always operate equipment in strict compliance to the handling and operation procedures set forth by this instruction manual.

Yamato Scientific Co., Ltd. assumes no responsibility for malfunction, damage, injury or death, resulting from negligent equipment use.

Never attempt to disassemble, repair or perform any procedure on DKN-C series units which are not expressly mandated by this manual. Doing so may result in equipment malfunction, serious personal injury or death.

Notice

- **Instruction manual descriptions and specifications are subject to change without notice.**
- **Yamato Scientific Co., Ltd. will replace flawed instruction manuals (pages missing, pages out of order, etc.) upon request.**

Instruction Manual
Forced Convection Oven
DKN302C/402C/602C/412C/612C/812C/912C
First Edition: June 9, 2014
Revised: June 18, 2015

Yamato Scientific America, Inc.

925 Walsh Avenue, Santa Clara,

CA 95050, U.S.A

<http://www.yamato-usa.com>

Toll Free: 1-800-2-YAMATO(1-800-292-6286)